

# FIBER OPTICAL COMMUNICATIONS (R17A0418)

## Lecture Notes

### B.TECH

(III YEAR – I SEM)  
(2019-20)

#### Prepared by:

Mrs.Anitha Patibandla, Associate Professor  
Mr.M.Anantha Gupta, Assistant Professor  
Ms.M.Nagma, Assistant Professor

Department of Electronics and Communication Engineering



**MALLA REDDY COLLEGE OF ENGINEERING & TECHNOLOGY**

**(Autonomous Institution – UGC, Govt. of India)**

Recognized under 2(f) and 12 (B) of UGC ACT 1956

(Affiliated to JNTUH, Hyderabad, Approved by AICTE-Accredited by NBA & NAAC-'A'Grade-ISO 9001:2015  
Certified) Maisammaguda, Dhulapally (Post Via. Kompally),  
Secunderabad-500100, Telangana State, India

## CORE ELECTIVE – II

### (R17A0418) FIBER OPTICAL COMMUNICATIONS

#### COURSE OBJECTIVES:

1. To realize the significance of optical fiber communications.
2. To understand the construction and characteristics of optical fiber cable.
3. To develop the knowledge of optical signal sources and power launching.
4. To identify and understand the operation of various optical detectors.
5. To under the design of optical systems and WDM.

#### UNIT I

**OVERVIEW OF OPTICAL FIBER COMMUNICATION:** Introduction, The general Optical Fiber communication system, advantages of optical fiber communications. Optical fiber wave guides- Introduction, Ray theory transmission, Total Internal Reflection, Acceptance angle, Numerical Aperture, Skew rays. Cylindrical fibers- Modes

Fiber materials, Fiber fabrication techniques, fiber optic cables, Classification of Optical Fibers: Single mode fibers, Graded Index fibers.

#### UNIT II

**SIGNAL DISTORTION IN OPTICAL FIBERS:** Attenuation, Absorption, Scattering and Bending losses, Core and Cladding losses. Information capacity determination, Group delay, Types of Dispersion - Material dispersion, Wave-guide dispersion, Polarization mode dispersion, Intermodal dispersion, pulse broadening.

**Optical fiber Connectors-** Connector types, Single mode fiber connectors, Connector return loss. Introduction to Optical Fibers splicing

#### UNIT III

**OPTICAL SOURCES:** Intrinsic and extrinsic material-direct and indirect band gaps-LED-LED structures-surface emitting LED-Edge emitting LED-quantum efficiency and LED power-light source materials-modulation of LED.

LASER diodes- modes and threshold conditions-Rate equations-external quantum efficiency-resonant frequencies-structures and radiation patterns-single mode laser-external modulation-temperature effects.

#### **UNIT IV**

**OPTICAL DETECTORS AND RECEIVERS:** Physical principles of PIN and APD, Detector response time, Temperature effect on Avalanche gain, Comparison of Photo detectors.

**Optical receiver operation-** Fundamental receiver operation, Digital signal transmission, error sources, Receiver configuration.

#### **UNIT V**

**OPTICAL SYSTEM DESIGN:** Considerations, Component choice, Multiplexing, Point-to- point links, System considerations, Link power budget with examples. Rise time budget with examples.

WDM –Passive DWDM Components-Elements of optical networks-SONET/SDH

#### **TEXT BOOKS:**

1. Optical Fiber Communications – Gerd Keiser, Tata Mc Graw-Hill International edition, 4th Edition, 2008.
2. Optical Fiber Communications – John M. Senior, PHI, 2nd Edition, 2002.

#### **REFERENCE BOOKS:**

1. Fiber Optic Communications – D.K. Mynbaev , S.C. Gupta and Lowell L. Scheiner, Pearson Education, 2005.
2. Text Book on Optical Fibre Communication and its Applications – S.C.Gupta, PHI, 2005.
3. Fiber Optic Communication Systems – Govind P. Agarwal , John Wiley, 3rd Edition, 2004.
4. Fiber Optic Communications – Joseph C. Palais, 4th Edition, Pearson Education, 2004.

#### **COURSE OUTCOMES:**

At the end of the course the student will be able to:

1. Understand and analyze the constructional parameters of optical fibers.
2. Be able to design the optical system.
3. Estimate the losses due to attenuation, absorption, scattering and bending.
4. Compare various optical detectors and choose suitable one for different applications.

# UNIT I

## OVERVIEW OF OPTICAL FIBER COMMUNICATION: INTRODUCTION

### Introduction

**Fiber-optic communication** is a method of transmitting information from one place to another by sending pulses of light through an optical fiber. The light forms an electromagnetic carrier wave that is modulated to carry information.<sup>[1]</sup> Fiber is preferred over electrical cabling when high bandwidth, long distance, or immunity to electromagnetic interference are required. This type of communication can transmit voice, video, and telemetry through local area networks, computer networks, or across long distances.

Optical fiber is used by many telecommunications companies to transmit telephone signals, Internet communication, and cable television signals. Researchers at Bell Labs have reached internet speeds of over 100 peta bit ×kilometer per second using fiber-optic communication.

The process of communicating using fiber-optics involves the following basic steps:

1. creating the optical signal involving the use of a transmitter, usually from an electrical signal
2. relaying the signal along the fiber, ensuring that the signal does not become too distorted or weak
3. receiving the optical signal
4. converting it into an electrical signal

### Historical Development

First developed in the 1970s, fiber-optics have revolutionized the telecommunications industry and have played a major role in the advent of the Information Age. Because of its advantages over electrical transmission, optical fibers have largely replaced copper wire communications in core networks in the developed world.

In 1880 Alexander Graham Bell and his assistant Charles Sumner Tainter created a very early precursor to fiber-optic communications, the Photophone, at Bell's newly established Volta Laboratory in Washington, D.C. Bell considered it his most important invention. The device allowed for the transmission of sound on a beam of light. On June 3, 1880, Bell conducted the world's first wireless telephone transmission between two buildings, some 213 meters apart.<sup>[4][5]</sup> Due to its use of an atmospheric transmission medium, the Photophone would not prove practical until advances in laser and optical fiber technologies permitted the secure transport of light. The Photophone's first practical use came in military communication systems many decades later.

In 1954 Harold Hopkins and Narinder Singh Kapany showed that rolled fiber glass allowed light to be transmitted. Initially it was considered that the light can traverse in only straight medium. Jun-ichi Nishizawa, a Japanese scientist at Tohoku University, proposed the use of optical fibers for communications in 1963. Nishizawa invented the PIN diode and the static induction transistor, both of which contributed to the development of optical fiber communications.

In 1966 Charles K. Kao and George Hockham at STC Laboratories (STL) showed that the losses of 1,000 dB/km in existing glass (compared to 5–10 dB/km in coaxial cable) were due to contaminants which could potentially be removed.

Optical fiber was successfully developed in 1970 by Corning Glass Works, with attenuation low enough for communication purposes (about 20 dB/km) and at the same time GaAs semiconductor lasers were developed that were compact and therefore suitable for transmitting light through fiber optic cables for long distances.

In 1973, Optelecom, Inc., co-founded by the inventor of the laser, Gordon Gould, received a contract from APA for the first optical communication systems. Developed for Army Missile Command in Huntsville, Alabama, it was a laser on the ground and a spout of optical fiber played out by missile to transmit a modulated signal over five kilometers.

After a period of research starting from 1975, the first commercial fiber-optic communications system was developed which operated at a wavelength around  $0.8\ \mu\text{m}$  and used GaAs semiconductor lasers. This first-generation system operated at a bit rate of 45 Mbit/s with repeater spacing of up to 10 km. Soon on 22 April 1977, General Telephone and Electronics sent the first live telephone traffic through fiber optics at a 6 Mbit/s throughput in Long Beach, California.

In October 1973, Corning Glass signed a development contract with CSELT and Pirelli aimed to test fiber optics in an urban environment: in September 1977, the second cable in this test series, named COS-2, was experimentally deployed in two lines (9 km) in Turin, for the first time in a big city, at a speed of 140 Mbit/s.

The second generation of fiber-optic communication was developed for commercial use in the early 1980s, operated at  $1.3\ \mu\text{m}$  and used InGaAsP semiconductor lasers. These early systems were initially limited by multi mode fiber dispersion, and in 1981 the single-mode fiber was revealed to greatly improve system performance, however practical connectors capable of working with single mode fiber proved difficult to develop. Canadian service provider SaskTel had completed construction of what was then the world's longest commercial fiber optic network, which covered 3,268 km (2,031 mi) and linked 52 communities.<sup>[11]</sup> By 1987, these systems were operating at bit rates of up to 1.7 Gb/s with repeater spacing up to 50 km (31 mi).

The first transatlantic telephone cable to use optical fiber was TAT-8, based on Desurvire optimised laser amplification technology. It went into operation in 1988.

Third-generation fiber-optic systems operated at  $1.55\ \mu\text{m}$  and had losses of about 0.2 dB/km. This development was spurred by the discovery of Indium gallium arsenide and the development of the Indium Gallium Arsenide photodiode by Pearsall. Engineers overcame earlier difficulties with pulse-spreading at that wavelength using conventional InGaAsP semiconductor lasers. Scientists overcame this difficulty by using dispersion-shifted fibers designed to have minimal dispersion at  $1.55\ \mu\text{m}$  or by limiting the laser spectrum to a single longitudinal mode.

These developments eventually allowed third-generation systems to operate commercially at 2.5 Gbit/s with repeater spacing in excess of 100 km (62 mi).

The fourth generation of fiber-optic communication systems used optical amplification to reduce the need for repeaters and wavelength-division multiplexing to increase data capacity. These two improvements caused a revolution that resulted in the doubling of system capacity every six months starting in 1992 until a bit rate of 10 Tb/s was reached by 2001. In 2006 a bit-rate of 14 Tbit/s was reached over a single 160 km (99 mi) line using optical amplifiers.

The focus of development for the fifth generation of fiber-optic communications is on extending the wavelength range over which a WDM system can operate. The conventional wavelength window, known as the C band, covers the wavelength range 1.53–1.57  $\mu\text{m}$ , and *dry fiber* has a low-loss window promising an extension of that range to 1.30–1.65  $\mu\text{m}$ . Other developments include the concept of "optical solutions", pulses that preserve their shape by counteracting the effects of dispersion with the nonlinear effects of the fiber by using pulses of a specific shape.

In the late 1990s through 2000, industry promoters, and research companies such as KMI, and RHK predicted massive increases in demand for communications bandwidth due to increased use of the Internet, and commercialization of various bandwidth-intensive consumer services, such as video on demand. Internet protocol data traffic was increasing exponentially, at a faster rate than integrated circuit complexity had increased under Moore's Law. From the bust of the dot-com bubble through 2006, however, the main trend in the industry has been consolidation of firms and offshoring of manufacturing to reduce costs. Companies such as Verizon and AT&T have taken advantage of fiber-optic communications to deliver a variety of high-throughput data and broadband services to consumers' homes.

### **Advantages of Fiber Optic Transmission**

Optical fibers have largely replaced copper wire communications in core networks in the developed world, because of its advantages over electrical transmission. Here are the main advantages of fiber optic transmission.

**Extremely High Bandwidth:** No other cable-based data transmission medium offers the bandwidth that fiber does. The volume of data that fiber optic cables transmit per unit time is far greater than copper cables.

**Longer Distance:** in fiber optic transmission, optical cables are capable of providing low power loss, which enables signals can be transmitted to a longer distance than copper cables.

**Resistance to Electromagnetic Interference:** in practical cable deployment, it's inevitable to meet environments like power substations, heating, ventilating and other industrial sources of interference. However, fiber has a very low rate of bit error (10<sup>-13</sup>), as a result of fiber being so resistant to electromagnetic interference. Fiber optic transmission is virtually noise free.

**Low Security Risk:** the growth of the fiber optic communication market is mainly driven by increasing awareness about data security concerns and use of the alternative raw material. Data or signals are transmitted via light in fiber optic transmission. Therefore there is no way to detect the data being transmitted by "listening in" to the electromagnetic energy "leaking" through the cable, which ensures the absolute security of information.

**Small Size:** fiber optic cable has a very small diameter. For instance, the cable diameter of a single OM3 multimode fiber is about 2mm, which is smaller than that of coaxial copper cable. Small size saves more space in fiber optic transmission.

**Light Weight:** fiber optic cables are made of glass or plastic, and they are thinner than copper cables. These make them lighter and easy to install. |

**Easy to Accommodate Increasing Bandwidth:** with the use of fiber optic cable, new equipment can be added to existing cable infrastructure. Because optical cable can provide vastly expanded capacity over the originally laid cable. And WDM (wavelength division multiplexing) technology, including CWDM and DWDM, enables fiber cables the ability to accommodate more bandwidth.



## Disadvantages of Fiber Optic Transmission

Though fiber optic transmission brings lots of convenience, its disadvantages also cannot be ignored. **Fragility:** usually optical fiber cables are made of glass, which lends to they are more fragile than electrical wires. In addition, glass can be affected by various chemicals including hydrogen gas (a problem in underwater cables), making them need more cares when deployed under ground.

**Difficult to Install:** it's not easy to splice fiber optic cable. And if you bend them too much, they will break. And fiber cable is highly susceptible to becoming cut or damaged during installation or construction activities. All these make it difficult to install.

**Attenuation & Dispersion:** as transmission distance getting longer, light will be attenuated and dispersed, which requires extra optical components like EDFA to be added.

**Cost Is Higher Than Copper Cable:** despite the fact that fiber optic installation costs are dropping by as much as 60% a year, installing fiber optic cabling is still relatively higher than copper cables. Because copper cable installation does not need extra care like fiber cables. However, optical fiber is still moving into the local loop, and through technologies such as FTTx (fiber to the home, premises, etc.) and PONs (passive optical networks), enabling subscriber and end user broadband access.

**Special Equipment Is Often Required:** to ensure the quality of fiber optic transmission, some special equipment is needed. For example, equipment such as OTDR (optical time-domain reflectometry) is required and expensive, specialized optical test equipment such as optical probes and power meter are needed at most fiber endpoints to properly provide testing of optical fiber.

## Applications of Optical Fiber Communications

Fiber optic cables find many uses in a wide variety of industries and applications. Some uses of fiber optic cables include:

- **Medical**

Used as light guides, imaging tools and also as lasers for surgeries

- **Defense/Government**

Used as hydrophones for seismic waves and SONAR , as wiring in aircraft, submarines and other vehicles and also for field networking

- **Data Storage**

Used for data transmission

- **Telecommunications**

Fiber is laid and used for transmitting and receiving purposes

- **Networking**

Used to connect users and servers in a variety of network settings and help increase the speed and accuracy of data transmission

- **Industrial/Commercial**

Used for imaging in hard to reach areas, as wiring where EMI is an issue, as sensory devices to make temperature, pressure and other measurements, and as wiring in automobiles and in industrial settings

- **Broadcast/CATV**

Broadcast/cable companies are using fiber optic cables for wiring CATV, HDTV, internet, video on-demand and other applications

Fiber optic cables are used for lighting and imaging and as sensors to measure and monitor a vast array of variables. Fiber optic cables are also used in research and development and testing across all the above mentioned industries

**The optical fibers have many applications. Some of them are as follows –**

- Used in telephone systems
- Used in sub-marine cable networks
- Used in data link for computer networks, CATV Systems
- Used in CCTV surveillance cameras
- Used for connecting fire, police, and other emergency services.
- Used in hospitals, schools, and traffic management systems.
- They have many industrial uses and also used for in heavy duty constructions.

## Block Diagram of Optical Fiber Communication System

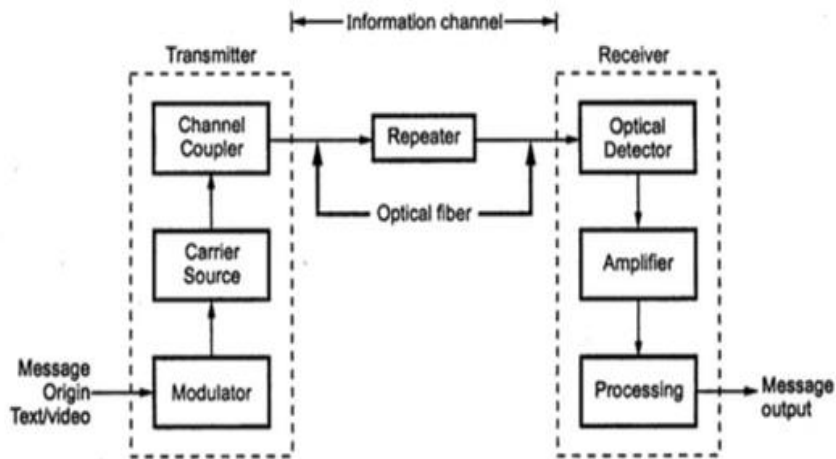

**Fig 1: Block Diagram of Optical Fiber Communication System**

### **Message origin:**

Generally message origin is from a transducer that converts a non-electrical message into an electrical signal. Common examples include microphones for converting sound waves into currents and video (TV) cameras for converting images into current. For data transfer between computers, the message is already in electrical form.

### **Modulator:**

The modulator has two main functions.

- 1) It converts the electrical message into proper format.
- 2) It impresses this signal onto the wave generated by the carrier source.

Two distinct categories of modulation are used i.e. analog modulation and digital modulation.

### **Carrier source:**

. Carrier source generates the wave on which the information is transmitted. This wave is called the carrier. For fiber optic system, a laser diode (LD) or a light emitting diode (LED) is used. They can be called as optic oscillators, they provide stable, single frequency waves with sufficient power for long distance propagation.

**Channel coupler:**

. Coupler feeds the power into information channel. For an atmospheric optic system, the channel coupler is a lens used for collimating the light emitted by the source and directing this light towards the receiver. The coupler must efficiently transfer the modulated light beam from the source to the optic fiber. The channel coupler design is an important part of fiber system because of possibility of high losses.

**Information channel:**

. The information channel is the path between the transmitter and receiver. In fiber optic communications, a glass or plastic fiber is the channel. Desirable characteristics of the information channel include low attenuation and large light acceptance cone angle. Optical amplifiers boost the power levels of weak signals. Amplifiers are needed in very long links to provide sufficient power to the receiver. Repeaters can be used only for digital systems. They convert weak and distorted optical signals to electrical ones and then regenerate the original digital pulse trains for further transmission.

. Another important property of the information channel is the propagation time of the waves travelling along it. A signal propagating along a fiber normally contains a range of fiber optic frequencies and divides its power along several ray paths. This results in a distortion of the propagation signal. In a digital system, this distortion appears as a spreading and deforming of the pulses. The spreading is so great that adjacent pulses begin to overlap and become unrecognizable as separate bits of information.

**Optical detector:**

. The information begin transmitted is detected by detector. In the fiber system the optic wave is converted into an electric current by a photodetector. The current developed by the detector is proportional to the power in the incident optic wave. Detector output current contains the transmitted information. This detector output is then filtered to remove the constant bias and then amplified.

. The important properties of photodetectors are small size, economy, long life, low power consumption, high sensitivity to optic signals and fast response to quick variations in the optic power.

. Signal processing includes filtering, amplification. Proper filtering maximizes the ratio of signal to unwanted power. For a digital system decision circuit is an additional block. The bit error rate (BER) should be very small for quality communications.

**Signal processing:**

. Signal processing includes filtering, amplification. Proper filtering maximizes the ratio of signal to unwanted power. For a digital system decision circuit is an additional block. The bit error rate (BER) should be very small for quality communications.

**Message output:**

. The electrical form of the message emerging from the signal processor is transformed into a sound wave or visual image. Sometimes these signals are directly usable when computers or other machines are connected through a fiber system.

**Electromagnetic Spectrum**

The radio waves and light are electromagnetic waves. The rate at which they alternate in polarity is called their frequency (f) measured in hertz (Hz). The speed of electromagnetic wave (c) in free space is approximately  $3 \times 10^8$  m/sec. The distance travelled during each cycle is called as wavelength ( $\lambda$ )

In fiber optics, it is more convenient to use the wavelength of light instead of the frequency with light frequencies; wavelength is often stated in microns or nanometers.

1 micron ( $\mu$ ) = 1

Micrometre ( $1 \times 10^{-6}$ ) 1 nano (n) =  $10^{-9}$  meter

Fiber optics uses visible and infrared light. Infrared light covers a fairly wide range of wavelengths and is generally used for all fiber optic communications. Visible light is normally used for very short range transmission using a plastic fiber.

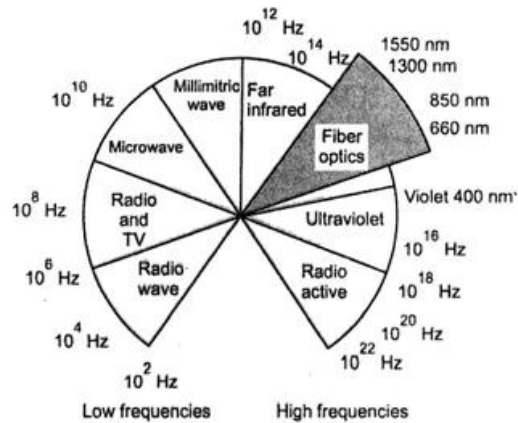
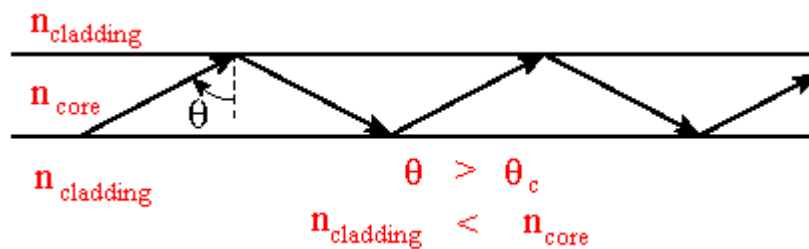

Fig 2: Electromagnetic Spectrum

### Optical Fiber Waveguides

In free space light travels at its maximum possible speed i.e.  $3 \times 10^8$  m/s or 186 x 10<sup>3</sup> miles/sec. When light travels through a material it exhibits certain behavior explained by laws of reflection, refraction.

An optical wave guide is a structure that "guides" a light wave by constraining it to travel along a certain desired path. If the transverse dimensions of the guide are much larger than the wavelength of the guided light, then we can explain how the optical waveguide works using geometrical optics and total internal reflection.



A wave guide traps light by surrounding a guiding region, called the core, made from a material with index of refraction  $n_{\text{core}}$ , with a material called the cladding, made from a material with index of refraction  $n_{\text{cladding}} < n_{\text{core}}$ . Light entering is trapped as long as  $\sin\theta > n_{\text{cladding}}/n_{\text{core}}$ .

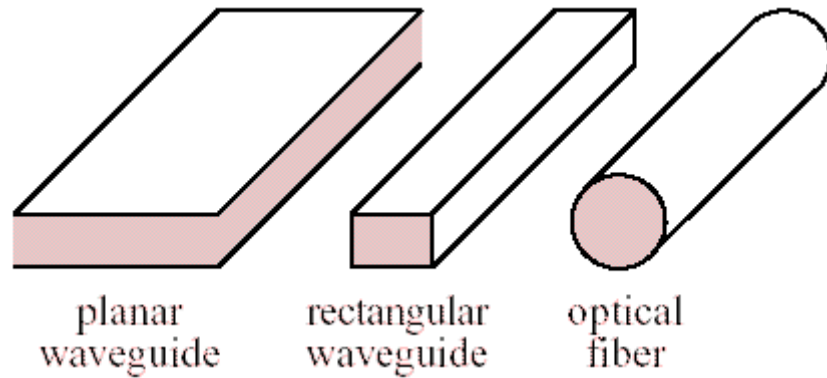

Light can be guided by planar or rectangular wave guides, or by optical fibers. An optical fiber consists of three concentric elements, the core, the cladding and the outer coating, often called the buffer. The core is usually made of glass or plastic. The core is the light-carrying portion of the fiber. The cladding surrounds the core. The cladding is made of a material with a slightly lower index of refraction than the core. This difference in the indices causes total internal reflection to occur at the core-cladding boundary along the length of the fiber. Light is transmitted down the fiber and does not escape through the sides of the fiber.

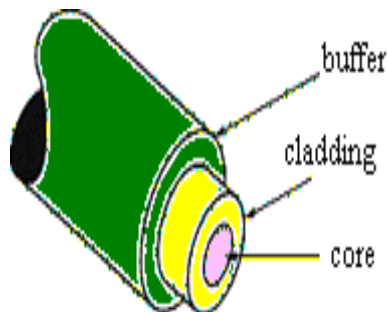

- Fiber Optic Core:
  - the inner light-carrying member with a high index of refraction.
- Cladding:
  - the middle layer, which serves to confine the light to the core. It has a lower index of refraction.

- Buffer:
  - the outer layer, which serves as a "shock absorber" to protect the core and cladding from damage. The coating usually comprises one or more coats of a plastic material to protect the fiber from the physical environment. Sometimes metallic sheaths are added to the coating for further physical protection.

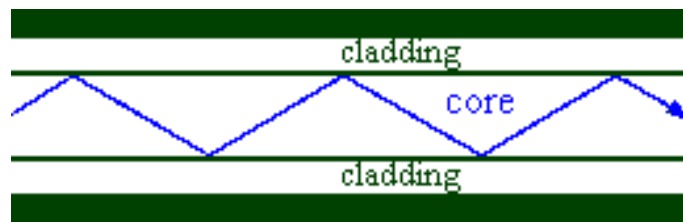

- 
- Light injected into the fiber optic core and striking the core-to-cladding interface at an angle greater than the critical angle is reflected back into the core. Since the angles of incidence and reflection are equal, the light ray continues to zigzag down the length of the fiber. The light is trapped within the core. Light striking the interface at less than the critical angle passes into the cladding and is lost.

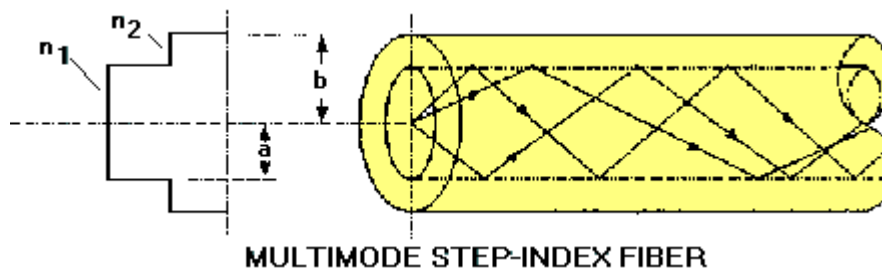

- Fibers for which the refractive index of the core is a constant and the index changes abruptly at the core-cladding interface are called step-index fibers. Step-index fibers are available with core diameters of 100  $\mu\text{m}$  to 1000  $\mu\text{m}$ . They are well suited to applications requiring high-power densities, such as delivering laser power for medical and industrial applications.



- Multimode step-index fibers trap light with many different entrance angles, each mode in a step-index multimode fiber is associated with a different entrance angle. Each mode therefore travels along a different path through the fiber. Different propagating modes have different velocities. As an optical pulse travels down a multimode fiber, the pulse begins to spread. Pulses that enter well separated from each other will eventually overlap each other. This limits the distance over which the fiber can transport data. Multimode step-index fibers are not well suited for data transport and communications.

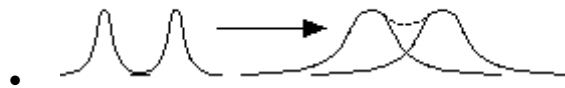

- In a multimode graded-index fiber the core has an index of refraction that decreases as the radial distance from the center of the core increases. As a result, the light travels faster near the edge of the core than near the center. Different modes therefore travel in curved paths with nearly equal travel times. This greatly reduces the spreading of optical pulses.

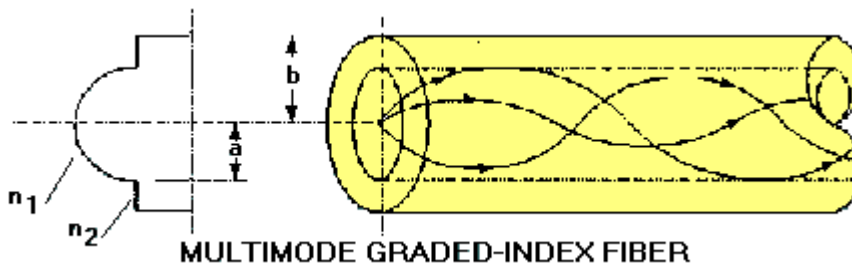

- A **single mode fiber** only allows light to propagate down its center and there are no longer different velocities for different modes. A single mode fiber is much thinner than a multimode fiber and can no longer be analyzed using geometrical optics. Typical core diameters are between 5 mm and 10 mm.

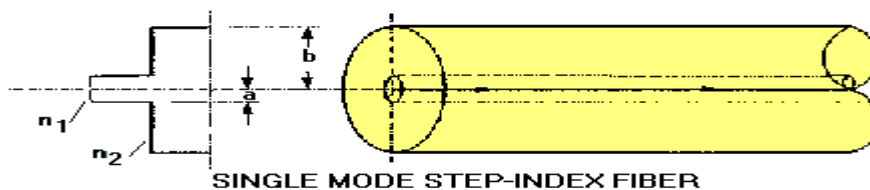

When laser light is coupled into a fiber, the distribution of the light emerging from the other end reveals if the fiber is a multimode or single mode fiber.

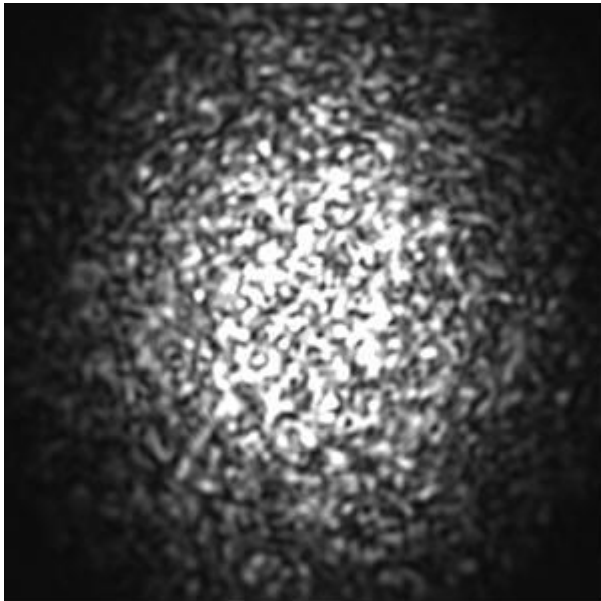

Light emerging from a multi-mode fiber

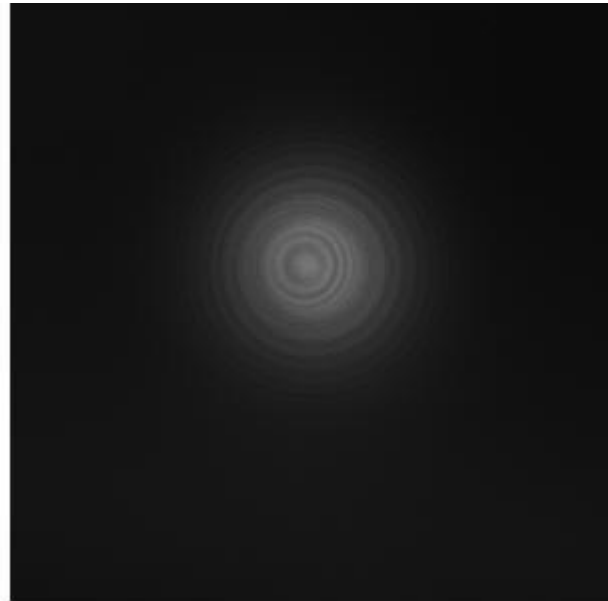

Light emerging from a single-mode fiber

Optical fibers are used widely in the medical field for diagnoses and treatment. Optical fibers can be bundled into flexible strands, which can be inserted into blood vessels, lungs and other parts of the body. An Endoscope is a medical tool carrying two bundles of optic fibers inside one long tube. One bundle directs light at the tissue being tested, while the other bundle carries light reflected from the tissue, producing a detailed image. Endoscopes can be designed to look at regions of the human body, such as the knees, or other joints in the body

**Problem:**

In a step-index fiber in the ray approximation, the ray propagating along the axis of the fiber has the shortest route, while the ray incident at the critical angle has the longest route. Determine the difference in travel time (in ns/km) for the modes defined by those two rays for a fiber with  $n_{\text{core}} = 1.5$  and  $n_{\text{cladding}} = 1.485$ .

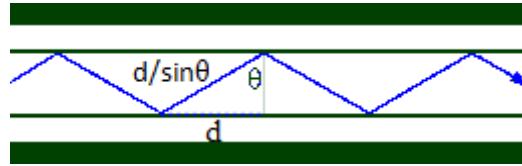

Solution:

If a ray propagating along the axis of the fiber travels a distance  $d$ , then a ray incident at the critical angle  $\theta_c$  travels a distance  $L = d/\sin\theta_c$ .

The respective travel times are  $t_d = dn_{\text{core}}/c$  and  $t_L = dn_{\text{core}}/(\sin\theta_c c)$ .

$$\sin\theta_c = n_{\text{cladding}}/n_{\text{core}}$$

$$\theta_c = 81.9 \text{ deg.}$$

For  $d = 1000 \text{ m}$  we have  $t_d = 5000 \text{ ns}$  and  $t_L = 5050.51 \text{ ns}$ .

The difference in travel time is therefore  $50.51 \text{ ns/km}$ .

## Ray theory

The phenomenon of splitting of white light into its constituents is known as dispersion. The concepts of reflection and refraction of light are based on a theory known as Ray theory or geometric optics, where light waves are considered as waves and represented with simple geometric lines or rays.

The basic laws of ray theory/geometric optics

- In a homogeneous medium, light rays are straight lines.
- Light may be absorbed or reflected
- Reflected ray lies in the plane of incidence and angle of incidence will be equal to the angle of reflection.

- At the boundary between two media of different refractive indices, the refracted ray will lie in the plane of incidence. Snell's Law will give the relationship between the angles of incidence and refraction.

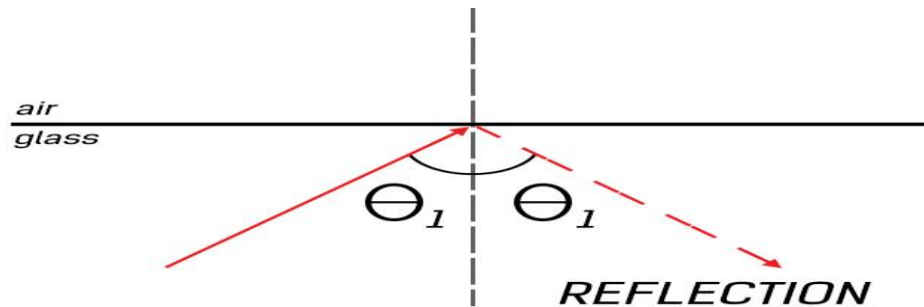

Reflection depends on the type of surface on which light is incident. An essential condition for reflection to occur with glossy surfaces is that the angle made by the incident ray of light with the normal at the point of contact should be equal to the angle of reflection with that normal.

The *images* produced from this reflection have different properties according to the shape of the surface. For example, for a flat mirror, the image produced is upright, has the same size as that of the object and is equally distanced from the surface of the mirror as the real object. However, the properties of a parabolic mirror are different and so on.

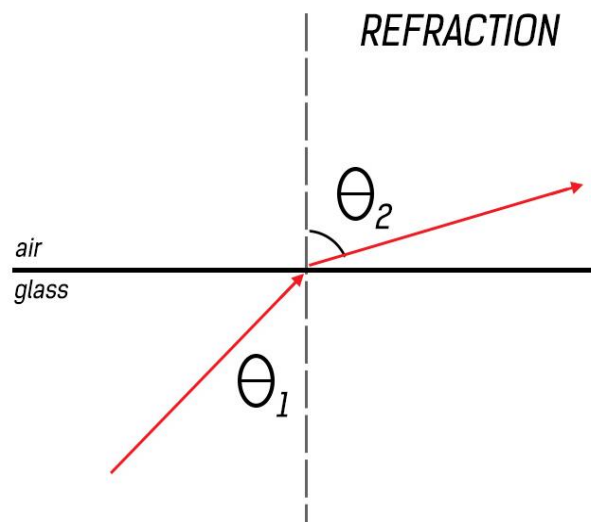

Refraction is the bending of light in a particular medium due to the speed of light in that medium. The

$$v = \frac{c}{n}$$

speed of light in any medium can be given by

$$\text{Refractive index } n = \frac{\text{Speed of light in air}}{\text{Speed of light in medium}} = \frac{c}{v}$$

The refractive index for vacuum and air is 1.0 for water it is 1.3 and for glass refractive index is 1.5.

Here  $n$  is the **refractive index** of that medium. When a ray of light is incident at the interface of two media with different refractive indices, it will bend either towards or away from the normal depending on the refractive indices of the media.

According to **Snell's law**, refraction can be represented as

$$n_1 \sin(\theta_1) = n_2 \sin(\theta_2)$$

$n_1$  = refractive index of first medium

$\theta_1$  = angle of incidence

$n_2$  = refractive index of second medium

$\theta_2$  = angle of refraction

For  $n_1 > n_2$ ,  $\theta_2$  is always greater than  $\theta_1$ . **Or** to put it in different words, light moving from a medium of high refractive index (glass) to a medium of lower refractive index (air) will move away from the normal.

### **Total internal reflection**

To consider the propagation of light within an optical fiber utilizing the ray theory model it is necessary to take account of the refractive index of the dielectric medium. Optical materials are characterized by their index of refraction, referred to as  $n$ . The refractive index of a medium is defined as the ratio of the velocity of light in a vacuum to the velocity of light in the medium.

When a beam of light passes from one material to another with a different index of refraction, the beam is bent (or refracted) at the interface (Figure 2).

$$n_I \sin I = n_R \sin R$$

where  $n_I$  and  $n_R$  are the indices of refraction of the materials through which the beam is refracted and  $I$  and  $R$  are the angles of incidence and refraction of the beam. If the angle of incidence is greater than the critical angle for the interface (typically about  $82^\circ$  for optical fibers), the light is reflected back into the incident medium without loss by a process known as total internal reflection (Figure 3).

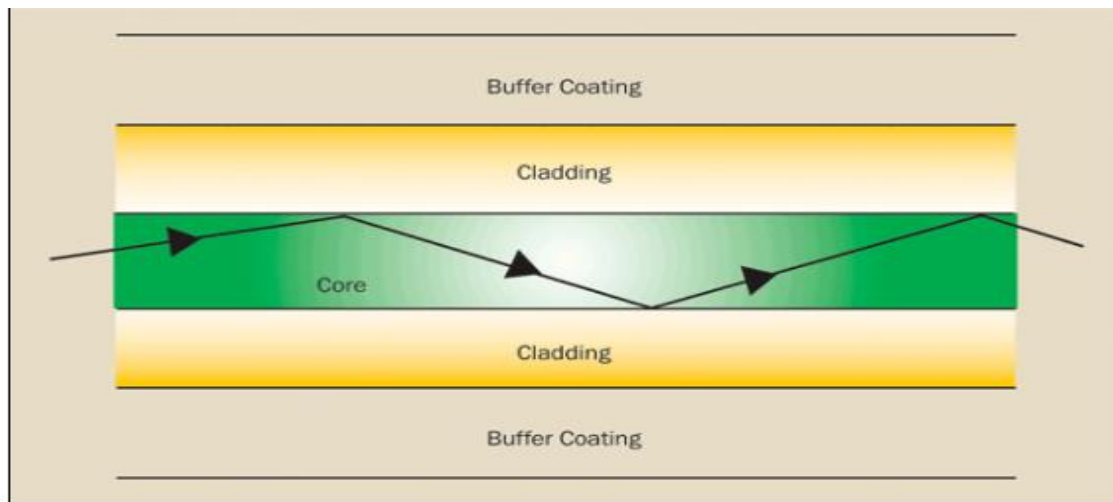

**Figure 3.** Total internal reflection allows light to remain inside the core of the fiber.

Refraction is described by Snell's law:

A ray of light travels more slowly in an optically dense medium than in one that is less dense, and the refractive index gives a measure of this effect. When a ray is incident on the interface between two dielectrics of differing refractive indices (e.g. glass–air), refraction occurs, as illustrated in Figure 1.2(a). It may be observed that the ray approaching the interface is propagating in a dielectric of refractive index  $n$  and is at an angle  $\phi$  to the normal at the surface of the interface.

If the dielectric on the other side of the interface has a refractive index  $n$  which is less than  $n_1$ , then the refraction is such that the ray path in this lower index medium is at an angle to the normal, where is greater than . The angles of incidence and refraction are related to each other and to the refractive indices of the dielectrics by Snell's law of refraction, which states that:

$$n_1 \sin \phi_1 = n_2 \sin \phi_2$$

Or

$$\frac{\sin \phi_1}{\sin \phi_2} = \frac{n_2}{n_1}$$

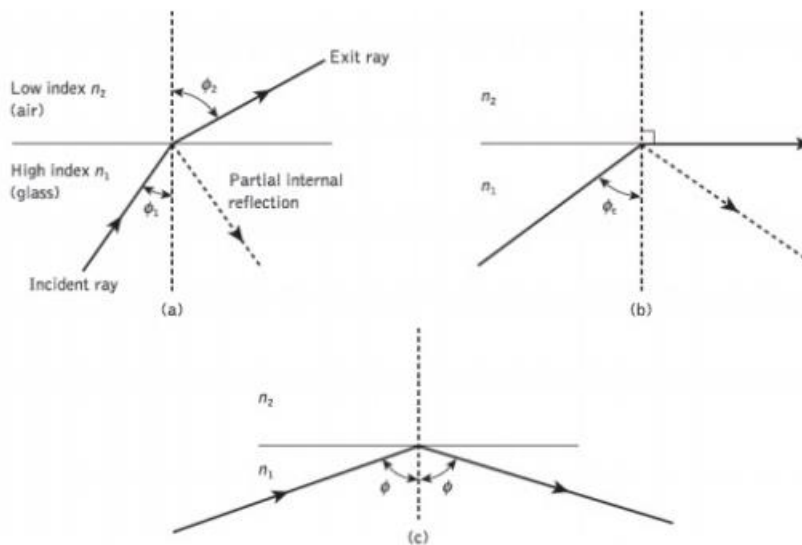

**Figure 1.2** Light rays incident on a high to low refractive index interface (e.g. glass air): (a) refraction; (b) the limiting case of refraction showing the critical ray at an angle  $\phi_c$  (c) total internal reflection where  $\phi > \phi_c$

It may also be observed in Figure 1.2(a) that a small amount of light is reflected back into the originating dielectric medium (partial internal reflection). As  $n$  is greater than  $n$ , the angle of refraction is always greater than the angle of incidence. Thus when the angle of refraction is  $90^\circ$  and the refracted ray emerges parallel to the interface between the dielectrics, the angle of incidence must be less than  $90^\circ$ .

This is the limiting case of refraction and the angle of incidence is now known as the critical angle  $\phi_c$ , as shown in Figure 1.2(b). From Eq. (1.1) the value of the critical angle is given by

$$\sin \phi_c = \frac{n_2}{n_1}$$

At angles of incidence greater than the critical angle the light is reflected back into the originating dielectric medium (total internal reflection) with high efficiency (around 99.9%). Hence, it may be observed in Figure 1.2(c) that total internal reflection occurs at the interface between two dielectrics of differing refractive indices when light is incident on the dielectric of lower index from the dielectric of higher index, and the angle of incidence of the ray exceeds the critical value. This is the mechanism by which light at a sufficiently shallow angle (less than  $90^\circ$  – may be considered to propagate down an optical fiber with low loss.

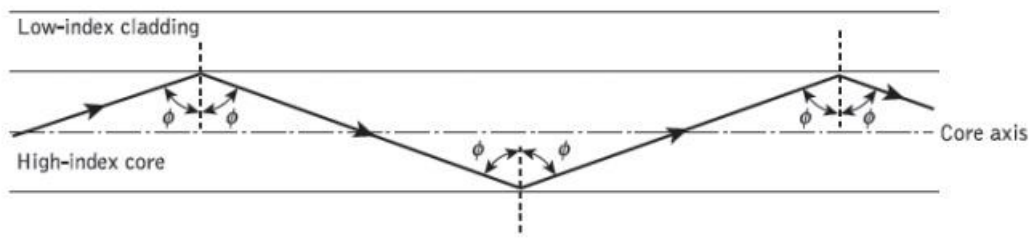

**Figure 1.3** The transmission of a light ray in a perfect optical fiber

Figure 1.3 illustrates the transmission of a light ray in an optical fiber via a series of total internal reflections at the interface of the silica core and the slightly lower refractive index silica cladding. The ray has an angle of incidence  $\phi$  at the interface which is greater than the critical angle and is reflected at the same angle to the normal.



The light ray shown in Figure 1.3 is known as a meridional ray as it passes through the axis of the fiber core. This type of ray is the simplest to describe and is generally used when illustrating the fundamental transmission properties of optical fibers. It must also be noted that the light transmission illustrated in Figure 1.3 assumes a perfect fiber, and that any discontinuities or imperfections at the core–cladding interface would probably result in refraction rather than total internal reflection, with the subsequent loss of the light ray into the cladding.

### Critical Angle

When the angle of incidence ( $\phi_1$ ) is progressively increased, there will be progressive increase of refractive angle ( $\phi_2$ ). At some condition ( $\phi_1$ ) the refractive angle ( $\phi_2$ ) becomes  $90^\circ$  to the normal. When this happens the refracted light ray travels along the interface. The angle of incidence ( $\phi_1$ ) at the point at which the refractive angle ( $\phi_2$ ) becomes  $90^\circ$  is called the critical angle. It is denoted by  $\phi_c$ .

The **critical angle** is defined as the minimum angle of incidence ( $\phi_1$ ) at which the ray strikes the interface of two media and causes an angle of refraction ( $\phi_2$ ) equal to  $90^\circ$ . Fig 1.6.5 shows critical angle refraction. When the angle of refraction is 90 degree to the normal the refracted ray is parallel to the interface between the two media.

Hence at critical angle  $\phi_1 = \phi_c$  and  $\phi_2 = 90^\circ$

Using Snell's law:  $n_1 \sin \phi_1 = n_2 \sin \phi_2$

$$\sin \phi_c = \frac{n_2}{n_1} \sin 90^\circ$$

$\therefore$

$$\sin 90^\circ = 1$$

$$\text{Critical angle } \phi_c = \sin^{-1} \left( \frac{n_2}{n_1} \right)$$

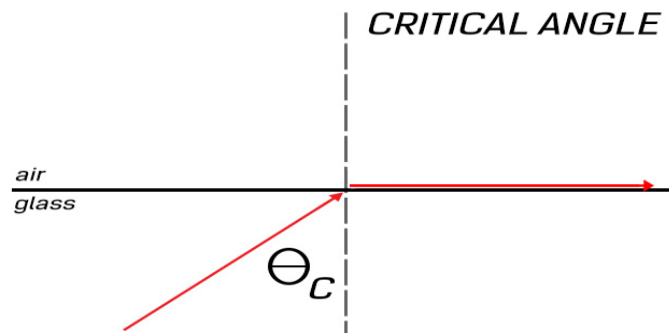

It is important to know about this property because reflection is also possible even if the surfaces are not reflective. If the *angle of incidence is greater than the critical angle* for a given setting, the resulting type of reflection is called **Total Internal Reflection**, and it is the basis of Optical Fiber Communication.

### Acceptance angle

In an optical fiber, a light ray undergoes its *first refraction* at the air-core interface. The angle at which this refraction occurs is crucial because this particular angle will dictate whether the subsequent *internal* reflections will follow the principle of Total Internal Reflection. This angle, at which the light ray first encounters the core of an optical fiber is called Acceptance angle.

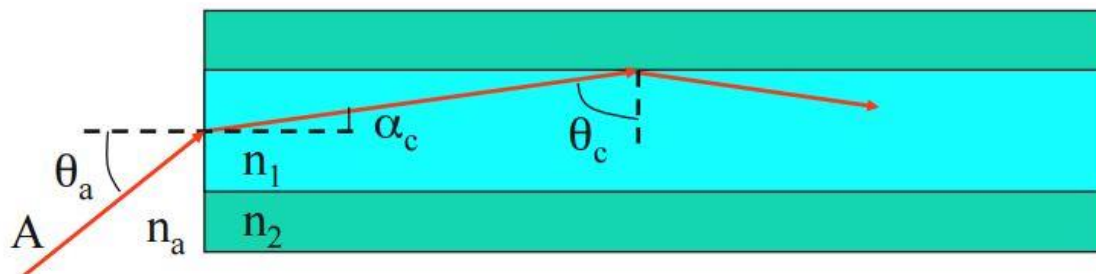

The objective is to have  $\theta_c$  greater than the critical angle for this particular setting. As you can notice,  $\theta_c$  depends on the orientation of the refracted ray at the input of the optical fiber. This in turn depends on  $\theta_a$ , the acceptance angle.

The acceptance angle can be calculated with the help of the formula below.

### Numerical Aperture

Numerical Aperture is a characteristic of any optical system. For example, photo-detector, optical fiber, lenses etc. are all optical systems. Numerical aperture is the ability of the optical system to collect all of the light incident on it, in one area.

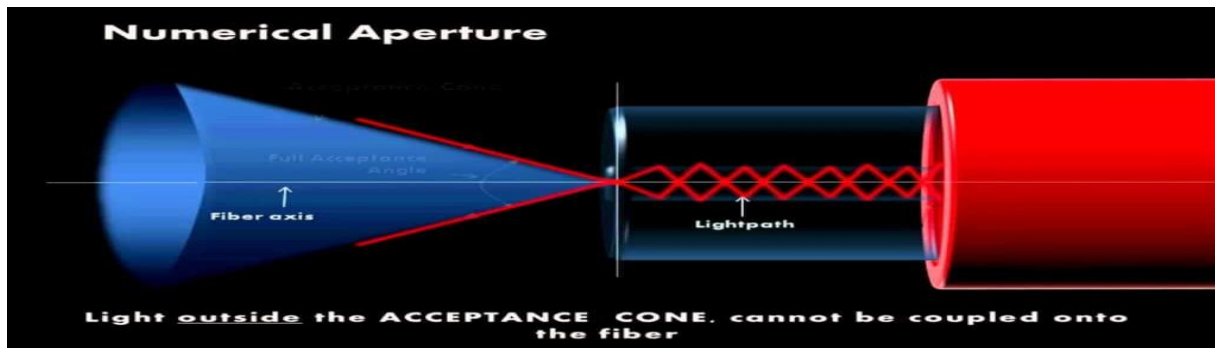

The blue cone is known as the cone of acceptance. As you can see it is dependent on the Acceptance Angle of the optical fiber. Light waves within the acceptance cone can be collected in a small area which can then be sent into the optical fiber (Source)

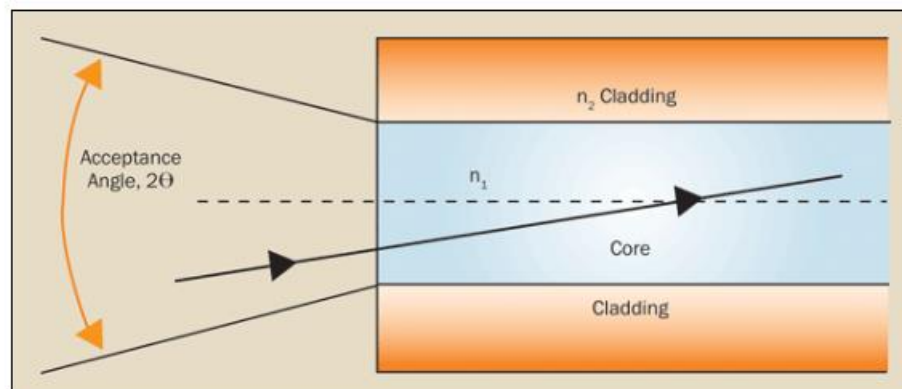

Numerical aperture (NA), shown in above Figure, is the measure of maximum angle at which light rays will enter and be conducted down the fiber. This is represented by the following equation:

$$NA = \sqrt{(n_{core}^2 - n_{cladding}^2)} = \sin \theta$$

**skew rays:** In a multimode optical fiber, a bound ray that travels in a helical path along the fiber and thus (a) is not parallel to the fiber axis, (b) does not lie in a meridional plane, and (c) does not intersect the fiber axis is known as a Skew Ray.

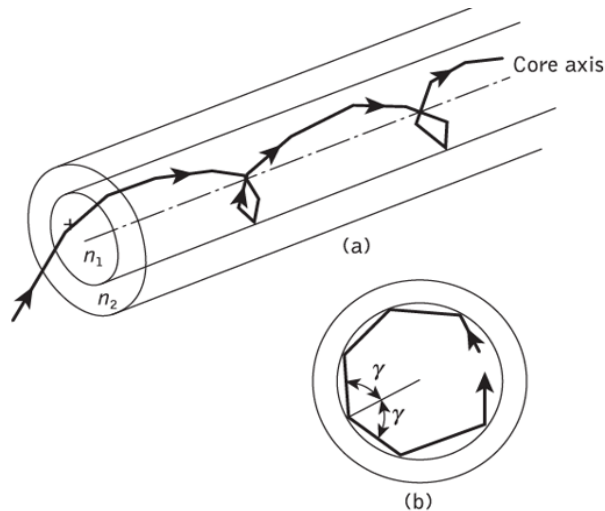

1. Skew rays are rays that travel through an optical fiber without passing through its axis.
2. A possible path of propagation of skew rays is shown in figure. Figure 24, view (a), provides an angled view and view (b) provides a front view.
3. Skew rays are those rays which follow helical path but they are not confined to a single plane. Skew rays are not confined to a particular plane so they cannot be tracked easily. Analyzing the meridional rays is sufficient for the purpose of result, rather than skew rays, because skew rays lead to greater power loss.
4. Skew rays propagate without passing through the center axis of the fiber. The acceptance angle for skew rays is larger than the acceptance angle of meridional rays.
5. Skew rays are often used in the calculation of light acceptance in an optical fiber. The addition of skew rays increases the amount of light capacity of a fiber. In large NA fibers, the increase may be significant.

6. The addition of skew rays also increases the amount of loss in a fiber. Skew rays tend to propagate near the edge of the fiber core. A large portion of the number of skew rays that are trapped in the fiber core are considered to be leaky rays.

7. Leaky rays are predicted to be totally reflected at the core-cladding boundary. However, these rays are partially refracted because of the curved nature of the fiber boundary. Mode theory is also used to describe this type of leaky ray loss.

## Cylindrical fiber

### 1. Modes

When light is guided down a fiber (as microwaves are guided down a waveguide), phase shifts occur at every reflective boundary. There is a finite discrete number of paths down the optical fiber (known as modes) that produce constructive (in phase and therefore additive) phase shifts that reinforce the transmission. Because each mode occurs at a different angle to the fiber axis as the beam travels along the length, each one travels a different length through the fiber from the input to the output. Only one mode, the zero-order mode, travels the length of the fiber without reflections from the sidewalls. This is known as a single-mode fiber. The actual number of modes that can be propagated in a given optical fiber is determined by the wavelength of light and the diameter and index of refraction of the core of the fiber.

The exact solution of Maxwell's equations for a cylindrical homogeneous core dielectric waveguide\* involves much algebra and yields a complex result. Although the presentation of this mathematics is beyond the scope of this text, it is useful to consider the resulting modal fields. In common with the planar guide (Section 1.3.2), TE (where  $E_z = 0$ ) and TM (where  $H_z = 0$ ) modes are obtained within the dielectric cylinder. The cylindrical waveguide, however, is bounded in two dimensions rather than one. Thus two integers,  $l$  and  $m$ , are necessary in order to specify the modes, in contrast to the single integer ( $m$ ) required for the planar guide.

For the cylindrical waveguide we therefore refer to TE/ $l$ m and TM/ $l$ m modes. These modes correspond to meridional rays (see Section 1.2.1) traveling within the fiber. However, hybrid modes where  $E_z$  and  $H_z$  are nonzero also occur within the cylindrical waveguide.

These modes, which result from skew ray propagation (see Section 1.2.4) within the fiber, are designated  $HE/m$  and  $EH/m$  depending upon whether the components of  $\mathbf{H}$  or  $\mathbf{E}$  make the larger contribution to the transverse (to the fiber axis) field. Thus an exact description of the modal fields in a step index fiber proves somewhat complicated.

Fortunately, the analysis may be simplified when considering optical fibers for communication purposes. These fibers satisfy the weakly guiding approximation where the relative index difference  $\Delta$  is small. This corresponds to small grazing angles  $\theta$  in Eq. (1.34). In fact  $\Delta$  is usually less than 0.03 (3%) for optical communications fibers. For weakly guiding structures with dominant forward propagation, mode theory gives dominant transverse field components. Hence approximate solutions for the full set of HE, EH, TE and TM modes may be given by two linearly polarized components.

These linearly polarized (LP) modes are not exact modes of the fiber except for the fundamental (lowest order) mode. However, as in weakly guiding fibers  $\Delta$  is very small, then HE–EH mode pairs occur which have almost identical propagation constants. Such modes are said to be degenerate. The superpositions of these degenerating modes characterized by a common propagation constant correspond to particular LP modes regardless of their HE, EH, TE or TM field configurations. This linear combination of degenerate modes obtained from the exact solution produces a useful simplification in the analysis of weakly guiding fibers.

The relationship between the traditional HE, EH, TE and TM mode designations and the  $LP/m$  mode designations is shown in Table 1.1. The mode subscripts  $l$  and  $m$  are related to the electric field intensity profile for a particular LP mode (see Figure 1.11(d)). There are in general  $2l$  field maxima around the circumference of the fiber core and  $m$  field maxima along a radius vector. Furthermore, it may be observed from Table 1.1 that the notation for labeling the HE and EH modes has changed from that specified for the exact solution in the cylindrical waveguide mentioned previously.

**Table 1.1** Correspondence between the lower order in linearly polarized modes and the traditional exact modes from which they are formed

<i>Linearly polarized</i>	<i>Exact</i>
LP <sub>01</sub>	HE <sub>11</sub>
LP <sub>11</sub>	HE <sub>21</sub> , TE <sub>01</sub> , TM <sub>01</sub>
LP <sub>21</sub>	HE <sub>31</sub> , EH <sub>11</sub>
LP <sub>02</sub>	HE <sub>12</sub>
LP <sub>31</sub>	HE <sub>41</sub> , EH <sub>21</sub>
LP <sub>12</sub>	HE <sub>22</sub> , TE <sub>02</sub> , TM <sub>02</sub>
LP <sub>lm</sub>	HE <sub>2m</sub> , TE <sub>0m</sub> , TM <sub>0m</sub>
LP <sub>lm</sub> ( <i>l</i> ≠ 0 or 1)	HE <sub>l+1,m</sub> , EH <sub>l-1,m</sub>

## 2. Mode coupling

We have thus far considered the propagation aspects of perfect dielectric waveguides. However, waveguide perturbations such as deviations of the fiber axis from straightness, variations in the core diameter, irregularities at the core-cladding interface and refractive index variations may change the propagation characteristics of the fiber. These will have the effect of coupling energy traveling in one mode to another depending on the specific perturbation. Ray theory aids the understanding of this phenomenon, as shown in Figure 1.13, which illustrates two types of perturbation. It may be observed that in both cases the ray no longer maintains the same angle with the axis. In electromagnetic wave theory this corresponds to a change in the propagating mode for the light. Thus individual modes do not normally propagate throughout the length of the fiber without large energy transfers to adjacent modes, even when the fiber is exceptionally good quality and is not strained or bent by its surroundings. This mode conversion is known as mode coupling or mixing. It is usually analyzed using coupled mode equations which can be obtained directly from Maxwell's equations.

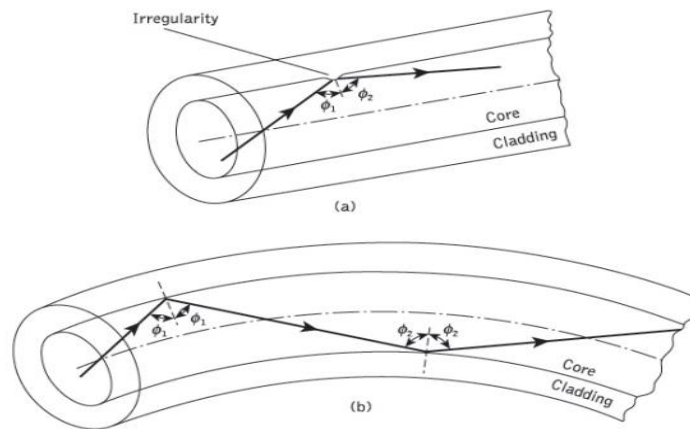

**Figure 1.13** Ray theory illustrations showing two of the possible fiber perturbations which give mode coupling: (a) irregularity at the core–cladding interface; (b) fiber bend

### 3. Step index fibers

The optical fiber considered in the preceding sections with a core of constant refractive index  $n_1$  and a cladding of a slightly lower refractive index  $n_2$  is known as step index fiber. This is because the refractive index profile for this type of fiber makes a step change at the core–cladding interface, as indicated in Figure 1.14, which illustrates the two major types of step index fiber. The refractive index profile may be defined as

$$n(r) = \begin{cases} n_1 & r < a & \text{(core)} \\ n_2 & r \geq a & \text{(cladding)} \end{cases} \quad (1.48)$$

in both cases.

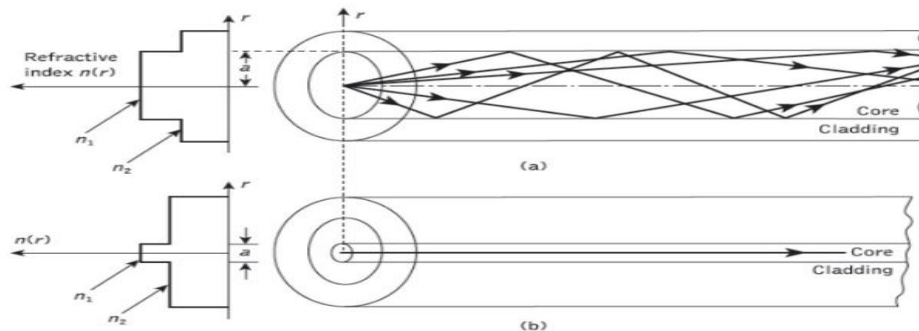

**Figure 1.14** The refractive index profile and ray transmission in step index fibers: (a) multimode step index fiber, (b) single-mode step index fiber



Figure 1.14(a) shows a multimode step index fiber with a core diameter of around  $50\mu\text{m}$  or greater, which is large enough to allow the propagation of many modes within the fiber core. This is illustrated in Figure 1.14(a) by the many different possible ray paths through the fiber. Figure 1.14(b) shows a single-mode or monomode step index fiber which allows the propagation of only one transverse electromagnetic mode (typically HE<sub>11</sub>), and hence the core diameter must be of the order of 2 to  $10\mu\text{m}$ . The propagation of a single mode is illustrated in Figure 1.14(b) as corresponding to a single ray path only (usually shown as the axial ray) through the fiber.

The single-mode step index fiber has the distinct advantage of low intermodal dispersion (broadening of transmitted light pulses), as only one mode is transmitted, whereas with multimode step index fiber considerable dispersion may occur due to the differing group velocities of the propagating modes. This in turn restricts the maximum bandwidth attainable with multimode step index fibers, especially when compared with single-mode fibers.

However, for lower bandwidth applications multimode fibers have several advantages over single-mode fibers. These are:

- a) The use of spatially incoherent optical sources (e.g. most light-emitting diodes) which cannot be efficiently coupled to single-mode fibers.
- b) Larger numerical apertures, as well as core diameters, facilitating easier coupling to optical sources
- c) Lower tolerance requirements on fiber connectors

Multimode step index fibers allow the propagation of a finite number of guided modes along the channel. The number of guided modes is dependent upon the physical parameters (i.e. relative refractive index difference, core radius) of the fiber and the wavelengths of the transmitted light which are included in the normalized frequency  $V$  for the fiber.

Mode propagation does not entirely cease below cutoff. Modes may propagate as unguided or leaky modes which can travel considerable distances along the fiber. Nevertheless, it is the guided modes which are of paramount importance in optical fiber communications as these are confined to the fiber over its full length. that the total number of guided modes or mode volume  $M_s$  for a step index fiber is related to the  $V$  value for the

fiber by the approximate expression

Which allows an estimate of the number of guided modes propagating in a particular multimode step index fiber.

#### 4. Graded index fibers

Graded index fibers do not have a constant refractive index in the core\* but a decreasing core index  $n(r)$  with radial distance from a maximum value of  $n_1$  at the axis to a constant value  $n_2$  beyond the core radius  $a$  in the cladding. This index variation may be represented as:

$$n(r) = \begin{cases} n_1(1 - 2\Delta(r/a)^\alpha)^{\frac{1}{2}} & r < a \quad (\text{core}) \\ n_1(1 - 2\Delta)^{\frac{1}{2}} = n_2 & r \geq a \quad (\text{cladding}) \end{cases} \quad (1.50)$$

where  $\Delta$  is the relative refractive index difference and  $\alpha$  is the profile parameter which gives the characteristic refractive index profile of the fiber core. Equation (1.50) which is a convenient method of expressing the refractive index profile of the fiber core as a variation of  $\alpha$ , allows representation of the step index profile when  $\alpha = \infty$ , a parabolic profile when  $\alpha = 2$  and a triangular profile when  $\alpha = 1$ . This range of refractive index profiles is illustrated in Figure 1.15

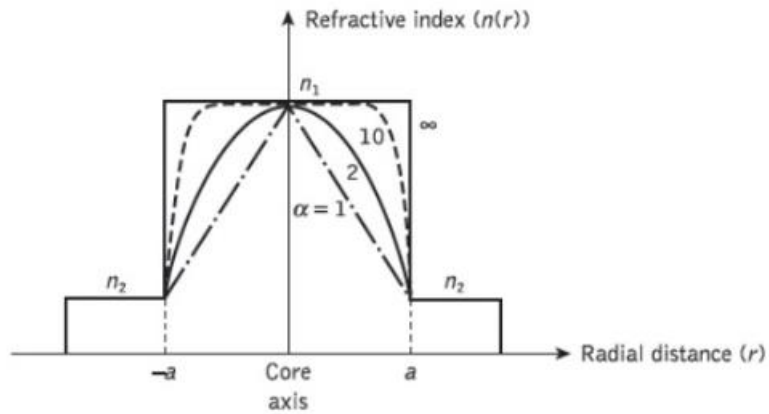

**Figure 1.15** Possible fiber refractive index profiles for different values of  $\alpha$  (given in Eq. (1.50))

The graded index profiles which at present produce the best results for multimode optical propagation have a near parabolic refractive index profile core with  $\alpha \sim 2$ . Fibers with such core index profiles are well established and consequently when the term 'graded index' is used without qualification it usually refers to a fiber with this profile.

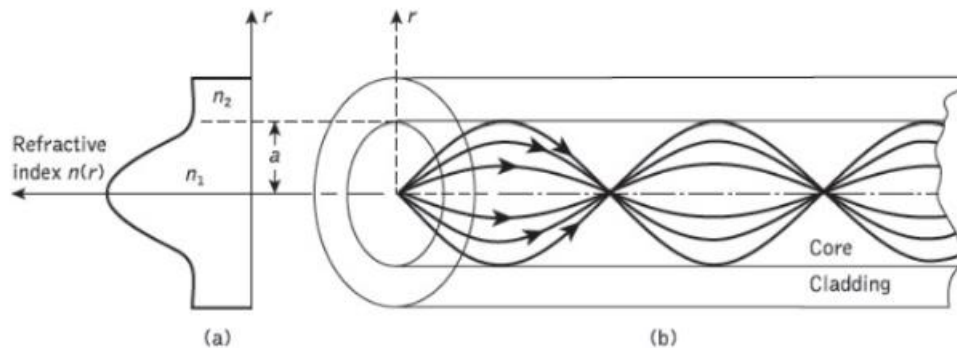

**Figure 1.16** The refractive index profile and ray transmission in a multimode graded index fiber

Where  $r$  = Radial distance from fiber axis

$$n(r) = \begin{cases} n_1 \left( 1 - 2\Delta \left( \frac{r}{a} \right)^\alpha \right) & \text{when } r < a \text{ (core)} \\ n_1 (1 - 2\Delta)^{\frac{1}{2}} \approx n_2 & \text{when } r \geq a \text{ (cladding)} \end{cases}$$

$a$  = Core radius

$n_1$  = Refractive index of core

$n_2$  = Refractive index of  
cladding  $\alpha$  = Shape of  
index profile.

Profile parameter  $\alpha$  determines the characteristic refractive index profile of fiber core.

For this reason in this section we consider the waveguiding properties of graded index fiber with a parabolic refractive index profile core. A multimode graded index fiber with a parabolic index profile core is illustrated in Figure 1.16. It may be observed that the meridional rays shown appear to follow curved paths through the fiber core. Using the concepts of geometric optics, the gradual decrease in refractive index from the center of the core creates many refractions of the rays as they are effectively incident on a large number of high to low index interfaces. This mechanism is illustrated in Figure 1.17 where a ray is shown to be gradually curved, with an ever-increasing angle of incidence, until the conditions for total internal reflection are met, and the ray travels back towards the core axis, again being continuously refracted.

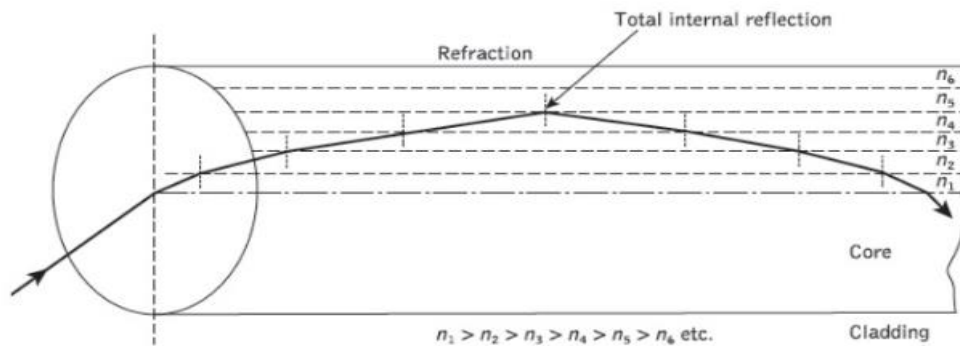

**Figure 1.17** An expanded ray diagram showing refraction at the various high to low index interfaces within a graded index fiber, giving an overall curved ray path into the outer regions of the core.

Multimode graded index fibers exhibit far less intermodal dispersion than multimode step index fibers due to their refractive index profile. Although many different modes are excited in the graded index fiber, the different group velocities of the modes tend to be normalized by the index grading. Again considering ray theory, the rays traveling close to the fiber axis have shorter paths when compared with rays which travel

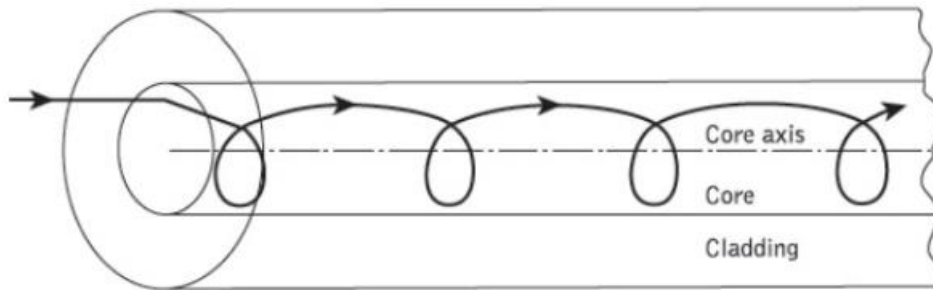

**Figure 1.18** A helical skew ray path within a graded index fiber

However, the near axial rays are transmitted through a region of higher refractive index and therefore travel with a lower velocity than the more extreme rays. This compensates for the shorter path lengths and reduces dispersion in the fiber. A similar situation exists for skew rays which follow longer helical paths, as illustrated in Figure 1.18. These travel for the most part in the lower index region at greater speeds, thus giving the same mechanism of mode transit time equalization. Hence, multi-mode graded index fibers with parabolic or near-parabolic index profile cores have transmission bandwidths which may be orders of magnitude greater than multimode step index fiber bandwidths. Consequently, although they are not capable of the bandwidths attainable with single-mode fibers, such multimode graded index fibers have the advantage of large core diameters (greater than  $30\ \mu\text{m}$ ) coupled with bandwidths suitable for long-distance communication. The parameters defined for step index fibers (i.e.  $NA$ ,  $\Delta$ ,  $V$ ) may be applied to graded index fibers and give a comparison between the two fiber types. However, it must be noted that for graded index fibers the situation is more complicated since the numerical aperture is a function of the radial distance from the fiber axis. Graded index fibers, therefore, accept less light than corresponding step index fibers with the same relative refractive index difference.

### **Single-mode fiber**

The advantage of the propagation of a single mode within an optical fiber is that the signal dispersion caused by the delay differences between different modes in a multimode fiber may be avoided. Multimode step index fibers do not lend themselves to the propagation of a single mode due to the difficulties of maintaining single-mode operation within the fiber when mode conversion (i.e. coupling) to other guided modes takes place at both input mismatches and fiber imperfections.

Hence, for the transmission of a single mode the fiber must be designed to allow propagation of only one mode, while all other modes are attenuated by leakage or absorption. Following the preceding discussion of multimode fibers, this may be achieved through choice of a suitable normalized frequency for the fiber. For single-mode operation, only the fundamental LP<sub>01</sub> mode can exist. Hence the limit of single-mode operation depends on the lower limit of guided propagation for the LP<sub>11</sub> mode. The cutoff normalized frequency for the LP<sub>11</sub> mode in step index fibers occurs at  $V_c = 2.405$ . Thus single-mode propagation of the LP<sub>01</sub> mode in step index fibers is possible over the range:

$$0 \leq V < 2.405 \quad (1.51)$$

as there is no cutoff for the fundamental mode. It must be noted that there are in fact two modes with orthogonal polarization over this range, and the term single-mode applies to propagation of light of a particular polarization. Also, it is apparent that the normalized frequency for the fiber may be adjusted to within the range given in Eq. (1.51) by reduction of the core radius.

### 1. Cutoff wavelength

It may be noted that single-mode operation only occurs above a theoretical cutoff wavelength  $\lambda_c$  given by:

$$\lambda_c = \frac{2\pi a n_1 (2\Delta)^{1/2}}{V_c} \quad (1.52)$$

where  $V_c$  is the cutoff normalized frequency. Hence  $\lambda_c$  is the wavelength above which a particular fiber becomes single-moded.

Dividing Eq. (1.52) by  $V = \frac{2\pi}{\lambda} a n_1 (2\Delta)^{1/2}$

$$\frac{\lambda_c}{\lambda} = \frac{V}{V_c} \quad (1.53)$$

Thus for step index fiber where  $V_c = 2.405$ , the cutoff wavelength is given by:

$$\lambda_c = \frac{V\lambda}{2.405} \quad (1.54)$$

An effective cutoff wavelength has been defined by the ITU-T which is obtained from a 2 m length of fiber containing a single 14 cm radius loop. This definition was produced because the first higher order LP<sub>11</sub> mode is strongly affected by fiber length and curvature near cutoff. Recommended cutoff wavelength values for primary coated fiber range from 1.1 to 1.28  $\mu\text{m}$  for single-mode fiber designed for operation in the 1.3 $\mu\text{m}$  wavelength region in order to avoid modal noise and dispersion problems. Moreover, practical transmission systems are generally operated close to the effective cutoff wavelength in order to enhance the fundamental mode confinement, but sufficiently distant from cutoff so that no power is transmitted in the second-order LP<sub>11</sub> mode.

## **2. Mode-field diameter and spot size**

Many properties of the fundamental mode are determined by the radial extent of its electromagnetic field including losses at launching and jointing, micro bend losses, waveguide dispersion and the width of the radiation pattern. Therefore, the MFD is an important parameter for characterizing single-mode fiber properties which takes into account the wavelength-dependent field penetration into the fiber cladding. In this context it is a better measure of the functional properties of single-mode fiber than the core diameter. For step index and graded (near parabolic profile) single-mode fibers operating near the cutoff wavelength  $\lambda_c$ , the field is well approximated by a Gaussian distribution. In this case the MFD is generally taken as the distance between the opposite  $1/e = 0.37$  field amplitude points and the power  $1/e^2 = 0.135$  points in relation to the corresponding values on the fiber axis.

Another parameter which is directly related to the MFD of a single-mode fiber is the spot size (or mode-field radius)  $\omega_0$ . Hence  $\text{MFD} = 2\omega_0$ , where  $\omega_0$  is the nominal half width of the input excitation.

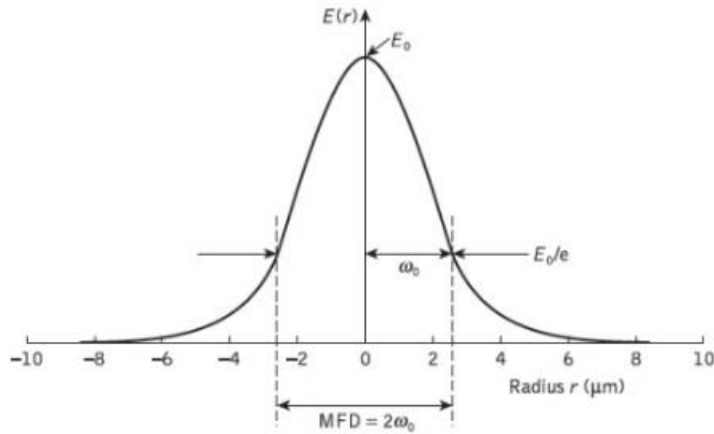

**Figure 1.19** Field amplitude distribution  $E(r)$  of the fundamental mode in a single-mode fiber illustrating the mode-field diameter (MFD) and spot size ( $\omega_0$ )

The MFD can therefore be regarded as the single-mode analog of the fiber core diameter in multimode fibers. However, for many refractive index profiles and at typical operating wavelengths the MFD is slightly larger than the single-mode fiber core diameter.

Often, for real fibers and those with arbitrary refractive index profiles, the radial field distribution is not strictly Gaussian and hence alternative techniques have been proposed. However, the problem of defining the MFD and spot size for non-Gaussian field distributions is a difficult one and at least eight definitions exist.

### 3. Effective refractive index

The rate of change of phase of the fundamental LP<sub>01</sub> mode propagating along a straight fiber is determined by the phase propagation constant. It is directly related to the wavelength of the LP<sub>01</sub>



mode  $\lambda_{01}$  by the factor  $2\pi$ , since  $\beta$  gives the increase in phase angle per unit length. Hence:

$$\beta\lambda_{01} = 2\pi \quad \text{or} \quad \lambda_{01} = \frac{2\pi}{\beta} \quad (1.55)$$

Moreover, it is convenient to define an effective refractive index for single-mode fiber, sometimes referred to as a phase index or normalized phase change coefficient  $n_{\text{eff}}$ , by the ratio of the propagation constant of the fundamental mode to that of the vacuum propagation constant:

$$n_{\text{eff}} = \frac{\beta}{k} \quad (1.56)$$

Hence, the wavelength of the fundamental mode  $\lambda_{01}$  is smaller than the vacuum wave-length  $\lambda$  by the factor  $1/n_{\text{eff}}$  where:

$$\lambda_{01} = \frac{\lambda}{n_{\text{eff}}} \quad (1.57)$$

It should be noted that the fundamental mode propagates in a medium with a refractive index  $n(r)$  which is dependent on the distance  $r$  from the fiber axis. The effective refractive index can therefore be considered as an average over the refractive index of this medium.

Within a normally clad fiber, not depressed-cladded fibers, at long wavelengths (i.e. small  $V$  values) the MFD is large compared to the core diameter and hence the electric field extends far into the cladding region. In this case the propagation constant  $\beta$  will be approximately equal to  $n_2k$  (i.e. the cladding wave number) and the effective index will be similar to the refractive index of the cladding  $n_2$ . Physically, most of the power is transmitted in the cladding material.

At short wavelengths, however, the field is concentrated in the core region and the propagation constant  $\beta$  approximates to the maximum wave number  $n_1k$ . Following this discussion, and as indicated previously, then the propagation constant in single-mode fiber varies over the interval  $n_2k < \beta < n_1k$ . Hence, the effective refractive index will vary over the range  $n_2 < n_{\text{eff}} < n_1$ .

#### 4. Group delay and mode delay factor

The transit time or group delay  $\tau_g$  for a light pulse propagating along a unit length of fiber is the inverse of the group velocity  $v_g$ . Hence:

$$\tau_g = \frac{1}{v_g} = \frac{d\beta}{d\omega} = \frac{1}{c} \frac{d\beta}{dk} \quad (1.61)$$

The group index of a uniform plane wave propagating in a homogeneous medium has been determined as:

$$N_g = \frac{c}{v_g}$$

However, for a single-mode fiber, it is usual to define an effective group index\*  $N_{ge}$  By:

$$N_{ge} = \frac{c}{v_g} \quad (1.62)$$

Where  $v_g$  is considered to be the group velocity of the fundamental fiber mode. Hence, the specific group delay of the fundamental fiber mode becomes:

$$\tau_g = \frac{N_{ge}}{c} \quad (1.63)$$

#### Fiber materials

Most of the fibers are made up of glass consisting of either Silica ( $\text{SiO}_2$ ) or Silicate. High-loss glass fibers are used for short-transmission distances and low-loss glass fibers are used for long distance applications. Plastic fibers are less used because of their higher attenuation than glass fibers. Glass Fibers.

The glass fibers are made from oxides. The most common oxide is silica whose refractive index is 1.458 at 850 nm. To get different index fibers, the dopants such as  $\text{GeO}_2$ ,  $\text{P}_2\text{O}_5$  are added to silica.  $\text{GeO}_2$  and  $\text{P}_2\text{O}_5$  increase the refractive index whereas fluorine or  $\text{B}_2\text{O}_3$  decreases the refractive index.

Few fiber compositions are given below as follows,

- (i)  $\text{GeO}_2 - \text{SiO}_2$  Core:  $\text{SiO}_2$  Cladding
- (ii)  $\text{P}_2\text{O}_5 - \text{SiO}_2$ , Core;  $\text{SiO}_2$  Cladding

The principle raw material for silica is sand. The glass composed of pure silica is referred to as silica glass, nitrous silica or fused silica. Some desirable properties of silica are,

- (i) Resistance to deformation at temperature as high as  $1000^\circ\text{C}$ .
- (ii) High resistance to breakage from thermal shock.
- (iii) Good chemical durability.
- (iv) High transparency in both the visible and infrared regions.

### **Basic Requirements and Considerations in Fiber Fabrication**

- (i) Optical fibers should have maximum reproducibility.
- (ii) Fibers should be fabricated with good stable transmission characteristics i.e., the fiber should have invariable transmission characteristics in long lengths.
- (iii) Different size, refractive index and refractive index profile, operating wavelengths material. Fiber must be available to meet different system applications.
- (iv) The fibers must be flexible to convert into practical cables without any degradation of their characteristics.
- (v) Fibers must be fabricated in such a way that a joining (splicing) of the fiber should not affect its transmission characteristics and the fibers may be terminated or connected together with less practical difficulties.

## Fiber Fabrication in a Two Stage Process

- (i) Initially glass is produced and then converted into perform or rod.

Glass fiber is a mixture of selenides, sulfides and metal oxides. It can be classified into,

1. Halide Glass Fibers
2. Active Glass Fibers
3. Chalgenide Glass Fibers.

Glass is made of pure  $\text{SiO}_2$  which refractive index 1.458 at 850 nm. The refractive index of  $\text{SiO}_2$  can be increased (or) decreased by adding various oxides are known as dopant. The oxides  $\text{GeO}_2$  or  $\text{P}_2\text{O}_3$  increases the refractive index and  $\text{B}_2\text{O}_3$  decreases the refractive index of  $\text{SiO}_2$ .

The various combinations are,

- (i)  $\text{GeO}_2$   $\text{SiO}_2$  Core;  $\text{SiO}_2$  cladding
- (ii)  $\text{P}_2\text{O}_3$  -  $\text{SiO}_2$  Core;  $\text{SiO}_2$  cladding
- (iii)  $\text{SiO}_2$  Core;  $\text{B}_2\text{O}_3$ , -  $\text{SiO}_2$  cladding
- (iv)  $\text{GeO}_2$ -  $\text{B}_2\text{O}_3$ -  $\text{SiO}_2$ , Core;  $\text{B}_2\text{O}_3$  -  $\text{SiO}_2$  cladding.

From above, the refractive index of core is maximum compared to the cladding.

### (1) Halide Glass Fibers

A halide glass fiber contains fluorine, chlorine, bromine and iodine. The most common Halide glass fiber is heavy "metal fluoride glass". It uses  $\text{ZrF}_4$  as a major component. This fluoride glass is known by the name ZBLAN Since it is constituents are  $\text{ZrF}_4$ ,  $\text{BaF}_2$ ,  $\text{LaF}_3$   $\text{AlF}_3$ , and  $\text{NaF}$ .

The percentages of these elements to form ZBLAN fluoride glass is shown as follows,

Materials	Molecular percentage
ZrF <sub>4</sub>	54%
BaF <sub>2</sub>	20%
LaF <sub>3</sub>	4.5%
AlF <sub>3</sub>	3.5%
NaF	18%

These materials add up to make the core of a glass fiber. By replacing ZrF<sub>4</sub> by HaF<sub>4</sub>, the lower refractive index glass is obtained.

The intrinsic losses of these glasses is 0.01 to 0.001 dB/km

### (2) Active Glass Fibers

Active glass fibers are formed by adding erbium and neodymium to the glass fibers. The above material performs amplification and attenuation

### (3) Chalcenide Glass Fibers

Chalcenide glass fibers are discovered in order to make use of the nonlinear properties of glass fibers. It contains either "S", "Se" or "Te", because they are highly nonlinear and it also contains one element from "Cl", "Br", "Cd", "Ba" or "Si". The mostly used chalcenide glass is AS<sub>2</sub>-S<sub>3</sub>, AS<sub>40</sub>S<sub>58</sub>Se<sub>2</sub> is used to make the core and AS<sub>2</sub>S<sub>3</sub> is used to make the cladding material of the glass fiber. The insertion loss is around 1 dB/m.

### Plastic Optical Fibers

Plastic optical fibers are the fibers which are made up of plastic material. The core of this fiber is made up of Polymethylmethacrylate (PMMA) or Perflourmated Polymer (PFP). Plastic optical fibers offer more attenuation than glass fiber and is used for short distance applications.

These fibers are tough and durable due to the presence of plastic **material**. The modulus of this plastic material is two orders **of** magnitude lower than that of silica and even a 1 mm diameter graded index plastic optical fiber can be installed **in** conventional fiber cable routes. The diameter of the core of these fibers is 10-20 times larger than that of glass fiber which reduces the connector losses without sacrificing coupling efficiencies. So we can use inexpensive connectors, splices and transceivers made up of plastic injection-molding technology. Graded index plastic optical fiber is in great demand in customer premises to deliver high-speed services due to its high bandwidth.

## UNIT-II

### SIGNAL DISTORTION IN OPTICAL FIBERS

#### Introduction

One of the important property of optical fiber is signal attenuation. It is also known as fiber loss or signal loss. The signal attenuation of fiber determines the maximum distance between transmitter and receiver. The attenuation also determines the number of repeaters required, maintaining repeater is a costly affair. Another important property of optical fiber is distortion mechanism. As the signal pulse travels along the fiber length it becomes more broader. After sufficient length the broad pulses starts overlapping with adjacent pulses. This creates error in the receiver. Hence the distortion limits the information carrying capacity of fiber.

#### Attenuation

- Attenuation is a measure of decay of signal strength or loss of light power that occurs as light pulses propagate through the length of the fiber.
- In optical fibers the attenuation is mainly caused by two physical factors absorption and scattering losses. Absorption is because of fiber material and scattering due to structural imperfection within the fiber. Nearly 90 % of total attenuation is caused by Rayleigh scattering only. Microbending of optical fiber also contributes to the attenuation of signal.
- The rate at which light is absorbed is dependent on the wavelength of the light and the characteristics of particular glass. Glass is a silicon compound, by adding different additional chemicals to the basic silicon dioxide the optical properties of the glass can be changed.
- The Rayleigh scattering is wavelength dependent and reduces rapidly as the wavelength of the incident radiation increases.

- The attenuation of fiber is governed by the materials from which it is fabricated, the manufacturing process and the refractive index profile chosen. Attenuation loss is measured in dB/km.

## Attenuation Units

As attenuation leads to a loss of power along the fiber, the output power is significantly less than the couples power. Let the couples optical power is  $p(0)$  i.e. at origin ( $z = 0$ ).

Then the power at distance  $z$  is given by,

$$P(z) = P(0)e^{-\alpha_p z} \quad \dots (2.1.1)$$

where,  $\alpha_p$  is fiber attenuation constant (per km).

$$\alpha_p = \frac{1}{z} \ln \left[ \frac{P(0)}{P(z)} \right]$$

$$\alpha_{dB/km} = 10 \cdot \frac{1}{z} \log \left[ \frac{P(0)}{P(z)} \right]$$

$$\alpha_{dB/km} = 4.343 \alpha_p \text{ per km}$$

This parameter is known as fiber loss or fiber attenuation.

- Attenuation is also a function of wavelength. Optical fiber wavelength as a function of wavelength is shown in Fig. 2.1.1.



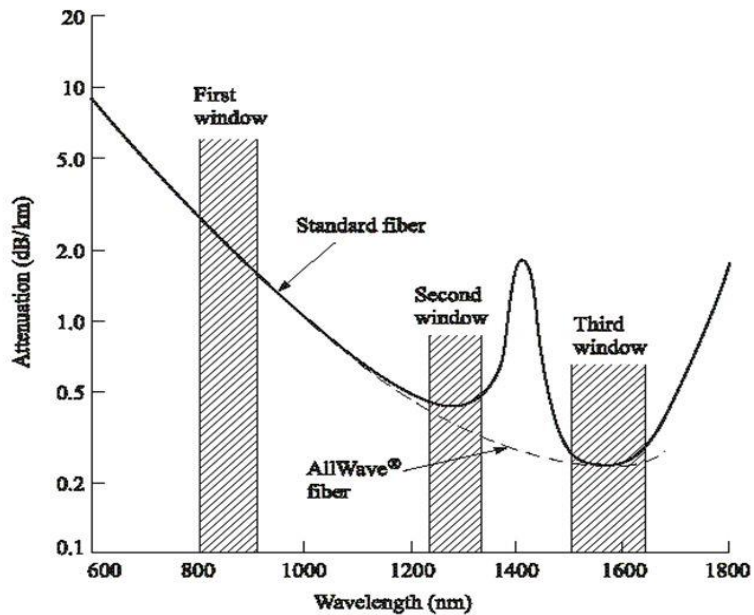

Optical fiber attenuation as a function of wavelength yields nominal values of 0.5 dB/km at 1310 nm and 0.3 dB/km at 1550 nm for standard single mode fiber. Absorption by the water molecules causes the attenuation peak around 1400nm for standard fiber. The dashed curve is the attenuation for low water peak fiber.

Irfan Khan

**Fig 2.1.1: Optical fiber wavelength as a function of wavelength**

**Example 2.1.1 :** A low loss fiber has average loss of 3 dB/km at 900 nm. Compute the length over which –

- a) Power decreases by 50 %
- b) Power decreases by 75 %.

Solution :  $\alpha = 3 \text{ dB/km}$

$$\Rightarrow \frac{P(0)}{P(z)} = 50 \% = 0.5$$

- a) Power decreases by 50 %.

□ is given by,

$$\left[ \frac{200 \mu\text{W}}{P(z)} \right] = 10^{2.4}$$

$$3 = 10 \cdot \frac{1}{z} \log [0.5]$$

**z = 1 km... Ans.**

b)  $\frac{P(0)}{P(z)} = 25 \% = 0.25$  Since power decrease by 75

%.

$$3 = 10 \times \frac{1}{z} \log [0.25]$$

**z = 2 km... Ans.**

**Example 2.1.2 :** For a 30 km long fiber attenuation 0.8 dB/km at 1300nm. If a 200  $\mu$ watt power is launched into the fiber, find the output power.

**Solution :**

$$z = 30 \text{ km}$$

$$\alpha = 0.8 \text{ dB/km}$$

$$P(0) = 200$$

$\mu\text{W}$

Attenuation in optical fiber is given by,

$$0.8 = 10 \times \frac{1}{30} \log \left[ \frac{200 \mu\text{W}}{P(z)} \right]$$

$$2.4 = 10 \times \log \left[ \frac{200 \mu\text{W}}{P(z)} \right]$$

**Example 2.1.3** : When mean optical power launched into an 8 km length of fiber is 12  $\mu$ W, the mean optical power at the fiber output is 3  $\mu$ W.

Determine –

Overall signal attenuation in dB.

The overall signal attenuation for a 10 km optical link using the same fiber with splices at 1 km intervals, each giving an attenuation of 1 dB.

**Solution: Given :**  $z = 8$  km

$$P(0) = 120 \mu\text{W}$$

$$P(z) = 3 \mu\text{W}$$

1) Overall attenuation is given by,

$$\alpha = 10 \cdot \log \left[ \frac{P(0)}{P(z)} \right]$$

$$\alpha = 10 \cdot \log \left[ \frac{120}{3} \right]$$

$$\alpha = 16.02 \text{ dB}$$

2) Overall attenuation for 10 km,

Attenuation per km

$$\alpha_{\text{dB}} = \frac{16.02}{z} = \frac{16.02}{8} = 2.00 \text{ dB/km}$$

Attenuation in 10

$$\text{km link} = 2.00 \times 10 = 20 \text{ dB}$$

In 10 km link there will be 9 splices at 1 km interval. Each splice introducing attenuation of 1 dB.

Total attenuation = 20 dB + 9 dB = **29 dB**

**Example 2.1.4** : A continuous 12 km long optical fiber link has a loss of 1.5 dB/km.

- What is the minimum optical power level that must be launched into the fiber to maintain as optical power level of 0.3 μW at the receiving end?
- What is the required input power if the fiber has a loss of 2.5 dB/km?

**Solution : Given data** : z = 12 km

$$= 1.5 \text{ dB/km}$$

$$P(0) = 0.3 \text{ μW}$$

- Attenuation in optical fiber is given by,

$$\alpha = 10 \times \frac{1}{z} \log \left( \frac{P(0)}{P(z)} \right)$$

$$1.5 = 10 \times \frac{1}{12} \log \left( \frac{0.3 \text{ μW}}{P(z)} \right)$$

$$\log \left( \frac{0.3 \text{ μW}}{P(z)} \right) = \frac{1.5}{0.833}$$

$$= 1.80$$

$$\left(\frac{0.3 \mu\text{W}}{P(z)}\right) = 10^{18}$$

$$P(z) = \left(\frac{0.3 \mu\text{W}}{10^{18}}\right) = \frac{0.3}{63.0}$$

$$P(z) = 4.76 \times 10^{-9} \text{W}$$

Optical power output =  **$4.76 \times 10^{-9} \text{ W}$**

... Ans.

ii) Input power =  $P(0)$

When

$$\alpha = 2.5 \text{ dB/km}$$

$$\left| \alpha = 10 \times \frac{1}{z} \log\left(\frac{P(0)}{P(z)}\right) \right|$$

$$2.5 = 10 \times \frac{1}{z} \log\left(\frac{P(0)}{4.76 \times 10^{-9}}\right)$$

$$\log\left(\frac{P(0)}{4.76 \times 10^{-9}}\right) = \frac{2.5}{0.833} = 3$$

$$\frac{P(0)}{4.76 \times 10^{-9}} = 10^3 = 1000$$

$$P(0) = 4.76 \mu\text{W}$$

Input power =  **$4.76 \mu\text{W}$**

... Ans.

**Example 2.1.5 :** Optical power launched into fiber at transmitter end is 150  $\mu\text{W}$ . The power at the end of 10 km length of the link working in first windows is – 38.2 dBm. Another system of same length working in second window is 47.5  $\mu\text{W}$ . Same length system working in third window has 50 % launched power. Calculate fiber attenuation for each case and mention wavelength of operation. [Jan./Feb.-2009, 4 Marks]

**Solution : Given data:**

$$P(0) = 150 \mu\text{W}$$

$$z = 10 \text{ km}$$

$$P(z) = -38.2 \text{ dBm} \Rightarrow \begin{cases} -38.2 = 10 \log \frac{P(z)}{1 \text{ mW}} \\ P(z) = 0.151 \mu\text{W} \end{cases}$$

$$z = 10 \text{ km}$$

$$\alpha = 10 \times \frac{1}{z} \log \left[ \frac{P(0)}{P(z)} \right]$$

Attenuation in 1<sup>st</sup> window:

$$\alpha_1 = 10 \times \frac{1}{10} \log \left[ \frac{150}{0.151} \right]$$

$$\alpha_1 = 2.99 \text{ dB/km}$$

Attenuation in 2<sup>nd</sup> window:

$$\alpha_2 = 10 \times \frac{1}{10} \log \left[ \frac{150}{47.5} \right]$$

$$\alpha_2 = 0.49 \text{ dB/km}$$

Attenuation in 3<sup>rd</sup> window:

$$\alpha_3 = 10 \times \frac{1}{10} \log \left[ \frac{150}{75} \right]$$

$$\alpha_3 = 0.30 \text{ dB/km}$$

Wavelength in 1<sup>st</sup> window is 850 nm.

Wavelength in 2<sup>nd</sup> window is 1300 nm.

Wavelength in 3<sup>rd</sup> window is 1550 nm.

**Example 2.1.6 :** The input power to an optical fiber is 2 mW while the power measured at the output end is 2  $\mu$ W. If the fiber attenuation is 0.5 dB/km, calculate the length of the fiber.

**Solution: Given :**  $P(0) = 2 \text{ mwatt} = 2 \times 10^{-3} \text{ watt}$

$$P(z) = 2 \text{ } \mu\text{watt} = 2 \times 10^{-6} \text{ watt}$$

$$\alpha = 0.5 \text{ dB/km}$$

$$\alpha = 10 \times \frac{1}{z} \left[ \frac{P(0)}{P(z)} \right]$$

$$z = 60 \text{ km} \frac{1}{0.5} \log \left[ \frac{2 \times 10^{-3}}{2 \times 10^{-6}} \right]$$

... Ans.

$$0.5 = \frac{1}{z} \times 3$$

$$z = \frac{3}{0.05}$$

### Absorption

- Absorption loss is related to the material composition and fabrication process of fiber. Absorption loss results in dissipation of some optical power as heat in the fiber cable. Although glass fibers are extremely pure, some impurities still remain as residue after purification. The amount of absorption by these impurities depends on their concentration and light wavelength.

Absorption in optical fiber is caused by these three mechanisms.

1. Absorption by atomic defects in the glass composition
2. Extrinsic absorption by impurity atoms in the glass material
3. Intrinsic absorption by the basic constituent atoms of the fiber material.

### Absorption by Atomic Defects

Atomic defects are imperfections in the atomic structure of the fiber materials such as missing molecules, high density clusters of atom groups. These absorption losses are negligible compared with intrinsic and extrinsic losses.

- The absorption effect is most significant when fiber is exposed to ionizing radiation in nuclear reactor, medical therapies, space missions etc. The radiation damages the internal



structure of fiber. The damages are proportional to the intensity of ionizing particles. This results in increasing attenuation due to atomic defects and absorbing optical energy. The total dose a material receives is expressed in rad (Si), this is the unit for measuring radiation absorbed in bulk silicon.

$$1 \text{ rad (Si)} = 0.01 \text{ J.kg}$$

The higher the radiation intensity more the attenuation as shown in Fig 2.2.1.

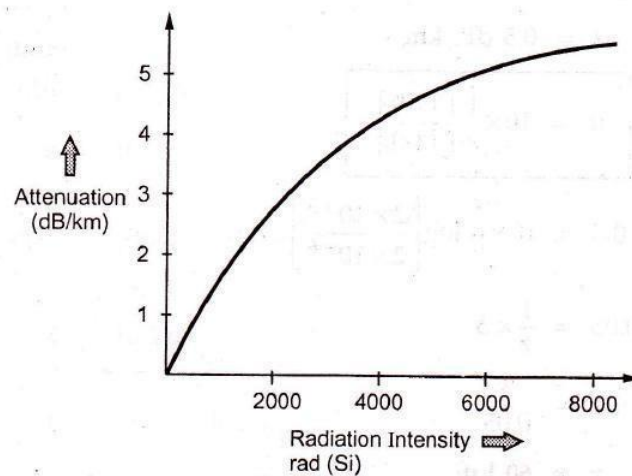

**Fig. 2.2.1 Ionizing radiation intensity Vs fiber attenuation**

### Extrinsic Absorption

Extrinsic absorption occurs due to electronic transitions between the energy level and because of charge transitions from one ion to another. A major source of attenuation is from transition of metal impurity ions such as iron, chromium, cobalt and copper. These losses can be upto 1 to 10 dB/km. The effect of metallic impurities can be reduced by glass refining techniques.

- Another major extrinsic loss is caused by absorption due to **OH (Hydroxyl)** ions impurities dissolved in glass. Vibrations occur at wavelengths between 2.7 and 4.2  $\mu\text{m}$ .

The absorption peaks occurs at 1400, 950 and 750 nm. These are first, second and third overtones respectively.

- Fig. 2.2.2 shows absorption spectrum for OH group in silica. Between these absorption peaks there are regions of low attenuation.

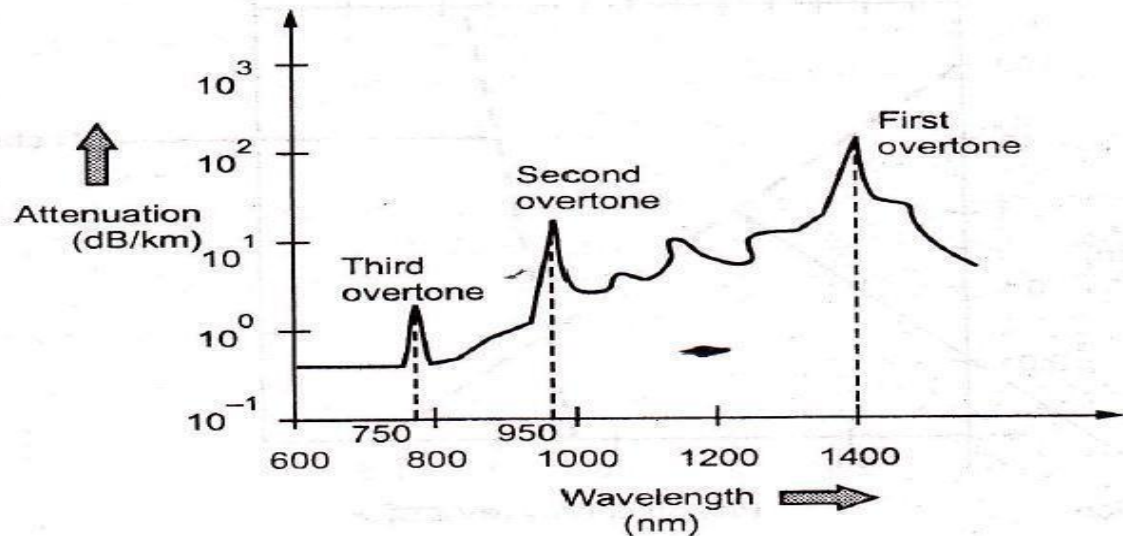

**Fig. 2.2.2 Absorption spectra for OH group**

### Intrinsic Absorption

Intrinsic absorption occurs when material is in absolutely pure state, no density variation and inhomogenities. Thus intrinsic absorption sets the fundamental lower limit on absorption for any particular material.

- Intrinsic absorption results from electronic absorption bands in UV region and from atomic vibration bands in the near infrared region.
- The electronic absorption bands are associated with the band gaps of amorphous glass materials. Absorption occurs when a photon interacts with an electron in the valence band and excites it to a higher energy level. UV absorption decays exponentially with increasing wavelength ( $\lambda$ ).

- In the IR (infrared) region above 1.2  $\mu\text{m}$  the optical waveguide loss is determined by presence of the OH ions and inherent IR absorption of the constituent materials. The inherent IR absorption is due to interaction between the vibrating band and the electromagnetic field of optical signal this results in transfer of energy from field to the band, thereby giving rise to absorption, this absorption is strong because of many bonds present in the fiber.

The ultraviolet loss at any wavelength is expressed as,

$$\alpha_{uv} = \frac{154.2}{46.6x+60} \times 10^{-2} \times e^{\left(\frac{4.65}{\lambda}\right)} \quad \dots (2.2.1)$$

where, x is mole fraction of  $\text{GeO}_2$ .

$\lambda$  is operating wavelength.

$\alpha_{uv}$  is in dB/km.

?? The loss in infrared (IR) region (above 1.2  $\mu\text{m}$ ) is given by expression :

$$\alpha_{IR} = 7.81 \times 10^{11} \times e^{\left(\frac{-48.48}{\lambda}\right)} \quad \dots (2.2.2)$$

The expression is derived for  $\text{GeO}_2$ - $\text{SiO}_2$  glass fiber.

### Rayleigh Scattering Losses

Scattering losses exist in optical fibers because of microscopic variations in the material density and composition. As glass is composed by a randomly connected network of molecules and several oxides (e.g.  $\text{SiO}_2$ ,  $\text{GeO}_2$  and  $\text{P}_2\text{O}_5$ ), these are the major cause of compositional structure fluctuation. These two effects result to variation in refractive index and Rayleigh type scattering of light.

**Rayleigh scattering** of light is due to small localized changes in the refractive index of the core and cladding material.

**There are two causes during the manufacturing of fiber.**

1. The first is due to slight fluctuation in mixing of ingredients. The random changes because of this are impossible to eliminate completely.
2. The other cause is slight change in density as the silica cools and solidifies. When light ray strikes such zones it gets scattered in all directions. The amount of scatter depends on the size of the discontinuity compared with the wavelength of the light so the shortest wavelength (highest frequency) suffers most scattering.

Fig. 2.3.1 shows graphically the relationship between wavelength and Rayleigh scattering loss.

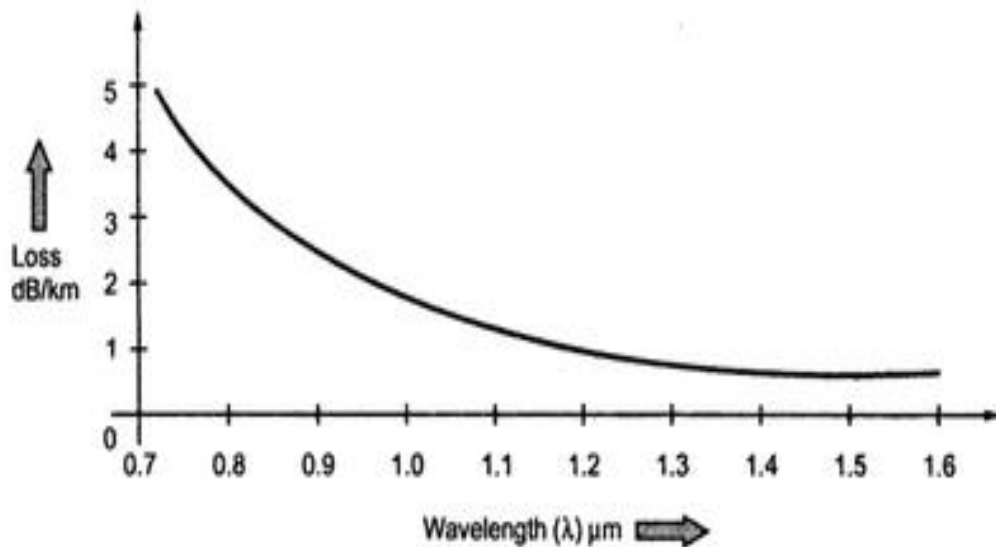

**Fig. 1 Scattering loss**

Scattering loss for single component glass is given by,

$$(2.3.1) \quad \alpha_{\text{scat}} = \frac{8\pi^3}{3\lambda^4} (n^2 - 1)^2 k_B T_f \beta_T \text{ nepers}$$

where,  $n$  = Refractive index

$k_B$  = Boltzmann's constant

$\beta_T$  = Isothermal compressibility of material

$T_f$  = Temperature at which density fluctuations are frozen into the glass as it solidifies (fictive temperature)

Another form of equation is

$$\alpha_{\text{scat}} = \frac{8\pi^3}{3\lambda^4} n^8 p^2 k_B T_f \beta_T \text{ neper} \quad \alpha_{\text{scat}} = \frac{8\pi^3}{3\lambda^4} (\delta_n^2)^2 \delta v \quad \dots (2.3.2)$$

where,  $P$  = Photoelastic coefficient

where,  $\delta_n^2$  = Mean square refractive index fluctuation

$\delta v$  = Volume of fiber

- Multimode fibers have higher dopant concentrations and greater compositional fluctuations. The overall losses in this fibers are more as compared to single mode fibers.

#### **Mie Scattering :**

- Linear scattering also occurs at inhomogenities and these arise from imperfections in the fiber's geometry, irregularities in the refractive index and the presence of bubbles etc. caused during manufacture. Careful control of manufacturing process can reduce Mie scattering to insignificant levels.

## Bending Loss

Radiative losses occur whenever an optical fiber undergoes a bend of finite radius of curvature. Fibers can be subjected to two types of bends: a) Macroscopic bends (having radii that are large as compared with the fiber diameter)

b) Random microscopic bends of fiber axis

Losses due to curvature and losses caused by an abrupt change in radius of curvature are referred to as 'bending losses.'

- The sharp bend of a fiber causes significant radiative losses and there is also possibility of mechanical failure. This is shown in Fig. 2.4.1.

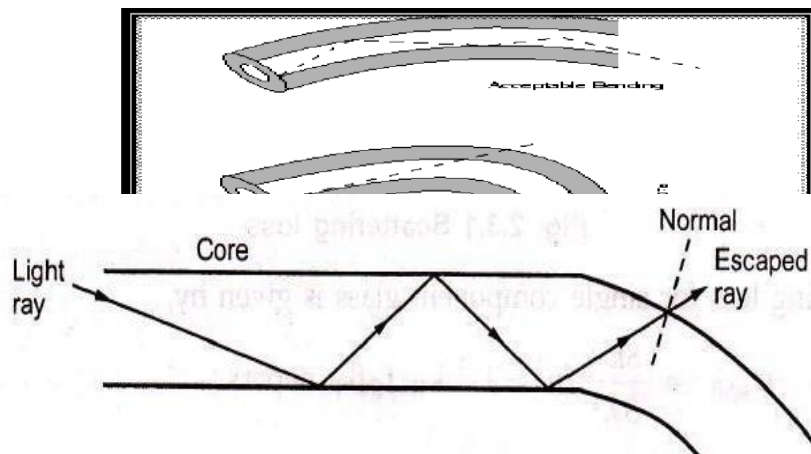

As the core bends the normal will follow it and the ray will now find itself on the wrong side of critical angle and will escape. The sharp bends are therefore avoided.

The radiation loss from a bent fiber depends on –Field strength of certain critical distance  $x_c$  from fiber axis where power is lost through radiation.

### The radius of curvature R.

The higher order modes are less tightly bound to the fiber core, the higher order modes radiate out of fiber firstly.

For multimode fiber, the effective number of modes that can be guided by curved fiber is where,  $\alpha$  is graded index profile.

$\Delta$  is core – cladding index difference.

$n_2$  is refractive index of cladding.  $k$  is

wave propagation constant  $\left(\frac{2\pi}{\lambda}\right)$ .

$N_\infty$  is total number of modes in a straight fiber.

$$N_\infty = \frac{\alpha}{\alpha+2} (n_1 k a)^2 \Delta \quad \dots (2.4.2)$$

### Microbending

#### Micro bending Loss

Another form of radiation loss in optical waveguide results from mode coupling caused by random micro bends of the optical fiber. Micro bends are repetitive small scale fluctuations in the radius of curvature of the fiber axis. They are caused either by non uniformities in the manufacturing of the fiber or by non uniform lateral pressures created during the cabling of the fiber. An increase in attenuation results from micro bending because the fiber curvature causes repetitive coupling of energy between the guided modes and the leaky or non guided modes in the fiber.

Micro bending losses can be minimized by placing a compressible jacket over the fiber. When external forces are applied to this configuration, the jacket will be deformed but the fiber will tend to stay relatively straight.

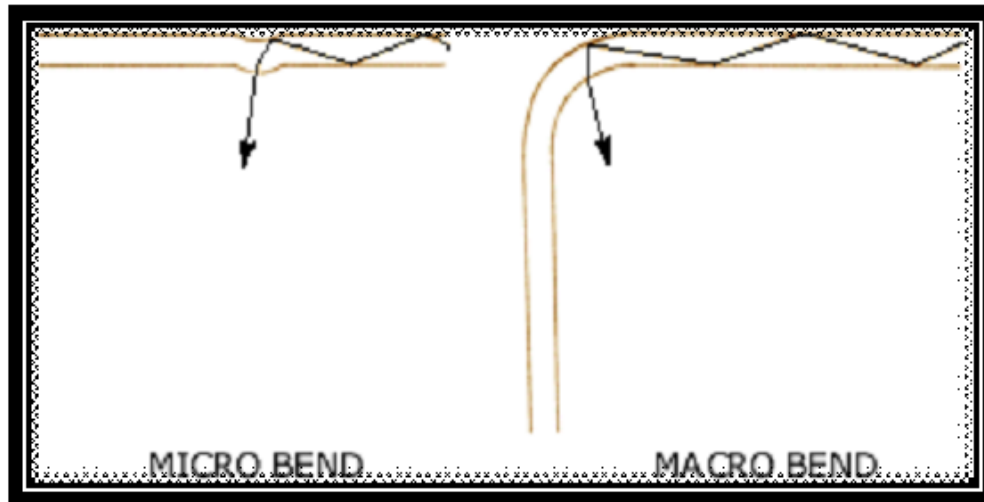

- Microbending is a loss due to small bending or distortions. This small microbending is not visible. The losses due to this are temperature related, tensile related or crush related.
- The effects of microbending on multimode fiber can result in increasing attenuation (depending on the spectral attenuation and testing).

Fig.2.4.2 il

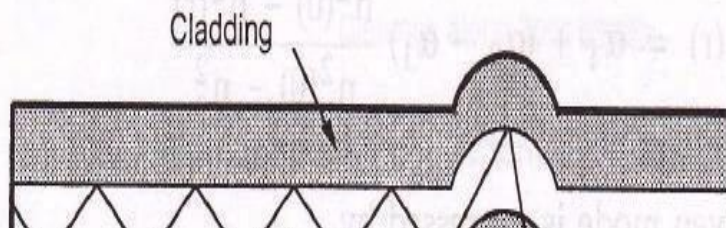



## Macrobending

For slight bends, the loss is extremely small and is not observed. As the radius of curvature decreases, the loss increases exponentially until at a certain critical radius of curvature loss becomes observable. If the bend radius is made a bit smaller once this threshold point has been reached, the losses suddenly become extremely large. It is known that any bound core mode has an evanescent field tail in the cladding which decays exponentially as a function of distance from the core. Since this field tail moves along with the field in the core, part of the energy of a propagating mode travels in the fiber cladding. When a fiber is bent, the field tail on the far side of the centre of curvature must move faster to keep up with the field in the core, for the lowest order fiber mode. At a certain critical distance  $x_c$ , from the centre of the fiber; the field tail would have to move faster than the speed of light to keep up with the core field. Since this is not possible the optical energy in the field tail beyond  $x_c$  radiates away.

The amount of optical radiation from a bent fiber depends on the field strength at  $x_c$  and on the radius of curvature  $R$ . Since higher order modes are bound less tightly to the fiber core than lower order modes, the higher order modes will radiate out of the fiber first.

- The change in spectral attenuation caused by macrobending is different to microbending. Usually there are no peaks and troughs because in a macrobending no light is coupled back into the core from the cladding as can happen in the case of microbends.

- The macrobending losses are caused by large scale bending of fiber. The losses are eliminated when the bends are straightened. The losses can be minimized by not exceeding the long term bend radii. Fig. 2.4.3 illustrates macrobending.

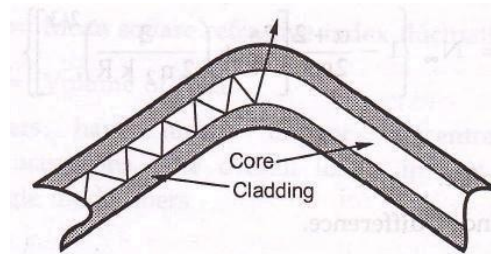

**Fig. 2.4.3 Macrobending**

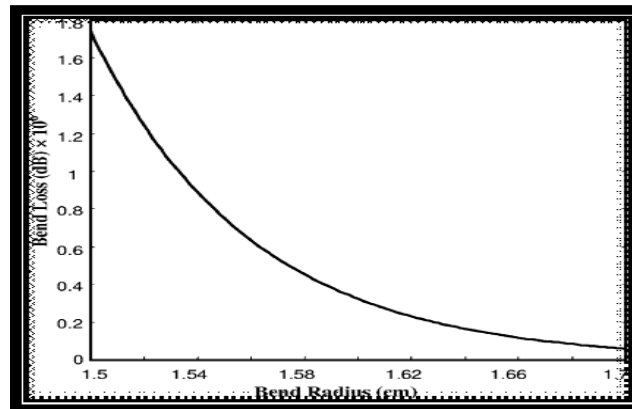

Macro bending Loss

### Core and Cladding Loss

- Since the core and cladding have different indices of refraction hence they have different attenuation coefficients  $\alpha_1$  and  $\alpha_2$  respectively.

$$\alpha(r) = \alpha_1 + (\alpha_2 - \alpha_1) \frac{n^2(0) - n^2(r)}{n^2(0) - n_2^2}$$

- For step index fiber, the loss for a mode order (v, m) is given by,

$$\alpha_{vm} = \alpha_1 \frac{P_{core}}{P} + \alpha_2 \frac{P_{cladding}}{P} \quad \dots$$

(2.5.1)

For low-order modes, the expression reduced to

$$\alpha_{vm} = \alpha_1 + (\alpha_2 + \alpha_1) \frac{P_{cladding}}{P} \quad \dots$$

(2.5.2)

where,  $\frac{P_{core}}{P}$  and  $\frac{P_{cladding}}{P}$  are fractional powers.

- For graded index fiber, loss at radial distance is expressed as,

... (2.5.3)

The loss for a given mode is expressed by,

$$\alpha_{\text{Graded Index}} = \frac{\int_0^{\infty} \alpha(r) P(r) r dr}{\int_0^{\infty} P(r) r dr} \quad \dots$$

(2.5.4)

where, P(r) is power density of that mode at radial distance r.

**Signal Distortion in Optical Waveguide**

- The pulse gets distorted as it travels along the fiber lengths. Pulse spreading in fiber is referred as dispersion. Dispersion is caused by difference in the propagation times of light rays that takes different paths during the propagation. The light pulses travelling down the fiber encounter dispersion effect because of this the pulse spreads out in time domain. Dispersion limits the information bandwidth. The distortion effects can be analyzed by studying the group velocities in guided modes.

### Information Capacity Determination

- Dispersion and attenuation of pulse travelling along the fiber is shown in Fig. 2.6.1.

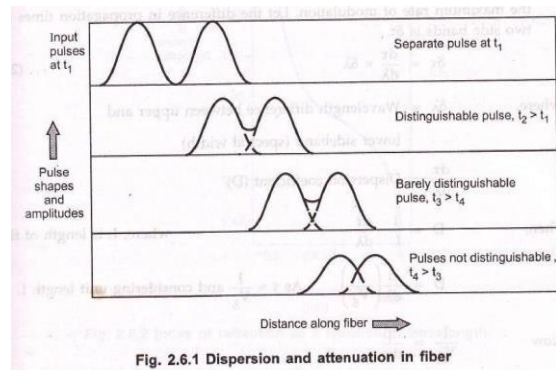

- Fig. 2.6.1 shows, after travelling some distance, pulse starts broadening and overlap with the neighbouring pulses. At certain distance the pulses are not even distinguishable and error will occur at receiver. Therefore the information capacity is specified by bandwidth- distance product (MHz . km). For step index bandwidth distance product is 20 MHz . km and for graded index it is 2.5 MHz . km.

### Group Delay

- Consider a fiber cable carrying optical signal equally with various modes and each mode contains all the spectral components in the wavelength band. All the spectral components travel independently and they observe different **time delay** and **group delay** in the direction of propagation. The velocity at which the energy in a pulse travels along the fiber is known as **group velocity**. Group velocity is given by,

$$V_g = \frac{\partial \omega}{\partial \beta} \quad \dots (2.6.1)$$

- Thus different frequency components in a signal will travel at different group velocities and so will arrive at their destination at different times, for digital modulation of carrier, this results in dispersion of pulse, which affects the maximum rate of modulation. Let the difference in propagation times for two side bands is  $\delta\tau$ .

$$\delta\tau = \frac{d\tau}{d\lambda} \times \delta\lambda$$

(2.6.2)

where,

$\delta\tau$  = Wavelength diff  
 (spectral width)  $\frac{d\tau}{d\lambda}$  = Dispersion coefficient (D)

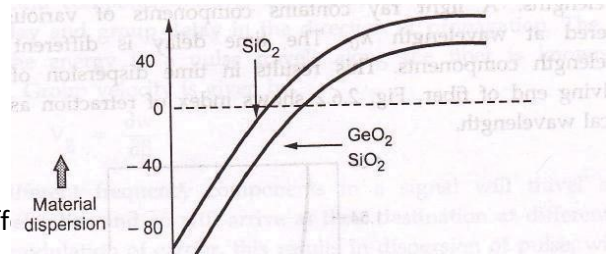

Then,

$$D = \frac{1}{L} \cdot \frac{d\tau}{d\lambda} \text{ where, } L \text{ is length of fiber.}$$

$$D = \frac{d}{d\lambda} \left( \frac{1}{v_g} \right)$$

$$\text{As } \tau = \frac{1}{v_g} \text{ and considering unit length } L = 1.$$

Now

$$\frac{1}{v_g} = \frac{d\beta}{d\omega}$$

$$\frac{1}{v_g} = \frac{d\lambda}{d\omega} \times \frac{d\beta}{d\lambda}$$

$$\frac{1}{v_g} = \frac{-\lambda^2}{2\pi c} \times \frac{d\beta}{d\lambda}$$

$$D = \frac{d}{d\lambda} \left( \frac{-\lambda^2}{2\pi c} \cdot \frac{d\beta}{d\lambda} \right)$$

- Dispersion is measured in picoseconds per nanometer per kilometer.

## Material Dispersion

Material dispersion is also called as chromatic dispersion. Material dispersion exists due to change in index of refraction for different wavelengths. A light ray contains components of various wavelengths centered at wavelength  $\lambda_{10}$ . The time delay is different for different wavelength components. This results in time dispersion of pulse at the receiving end of fiber. Fig. 2.6.2 shows index of refraction as a function of optical wavelength.

The material dispersion for unit length ( $L = 1$ ) is given by

$$D_{\text{mat}} = -\frac{\lambda}{c} \times \frac{d^2n}{d\lambda^2}$$

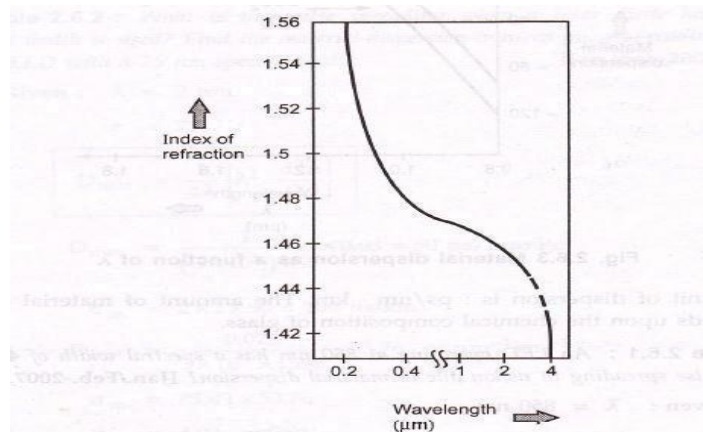

Fig. 2.6.2 Index of refraction as a function of wavelength

... (2.6.4)

where,  $c$  = Light velocity

$\lambda$  = Center wavelength

$\frac{d^2n}{d\lambda^2}$  = Second derivative of index of refraction w.r.t wavelength

Negative sign shows that the upper sideband signal (lowest wavelength) arrives before the lower sideband (highest wavelength).

- The unit of dispersion is : ps/nm . km. The amount of material dispersion depends upon the chemical composition of glass.

**Example 2.6.1** : An LED operating at 850 nm has a spectral width of 45 nm. What is the pulse spreading in ns/km due to material dispersion?

**Solution : Given :**  $\lambda = 850$  nm

$\sigma = 45$  nm

pulse broadening due to material dispersion is given by,

$$\sigma_m = \sigma LM$$

Considering length  $L = 1$  metre



$$\text{Material dispersion constant } D_{\text{mat}} = \frac{-\lambda}{c} \cdot \frac{d^2n}{d\lambda^2}$$

For LED source operating at 850 nm,  $\left| \lambda^2 \frac{d^2n}{d\lambda^2} \right| = 0.025$

$$M = \frac{1}{c\lambda} \left| \lambda^2 \frac{d^2n}{d\lambda^2} \right| = \frac{1}{(3 \times 10^8) (850)} \times 0.025$$

$$M = 9.8 \text{ ps/nm/km}$$

$$\sigma_m = 441 \text{ ns/km} \quad \dots$$

**Ans.**

## Waveguide Dispersion

- Waveguide dispersion is caused by the difference in the index of refraction between the core and cladding, resulting in a 'drag' effect between the core and cladding portions of the power.
- Waveguide dispersion is significant only in fibers carrying fewer than 5-10 modes. Since multimode optical fibers carry hundreds of modes, they will not have observable waveguide dispersion.
- The group delay ( $\tau_{\text{wg}}$ ) arising due to waveguide dispersion.

$$(\tau_{wg}) = \frac{L}{c} \left[ n_2 + n_2 \Delta \frac{d(kb)}{dk} \right] \quad \dots$$

(2.6.5)

Where,  $b$  = Normalized propagation constant  
 $k = 2\pi / \lambda$  (group velocity)

Normalized frequency  $V$ ,

$$V = ka(n_1^2 - n_2^2)^{\frac{1}{2}}$$

$$\tau_{wg} = \frac{L}{c} \left[ n_2 + n_2 \Delta \frac{d(v_b)}{dv} \right]$$

The second term  $\frac{d(v_b)}{dv}$  is waveguide dispersion and is mode dependent term..

- As frequency is a function of wavelength, the group velocity of the energy varies with frequency. This produces additional losses (waveguide dispersion). The propagation constant ( $b$ ) varies with wavelength, the causes of which are independent of material dispersion.

### Chromatic Dispersion

- The combination of material dispersion and waveguide dispersion is called chromatic dispersion. These losses primarily concern the spectral width of transmitter and choice of correct wavelength.

- A graph of effective refractive index against wavelength illustrates the effects of material, chromatic and waveguide dispersion.

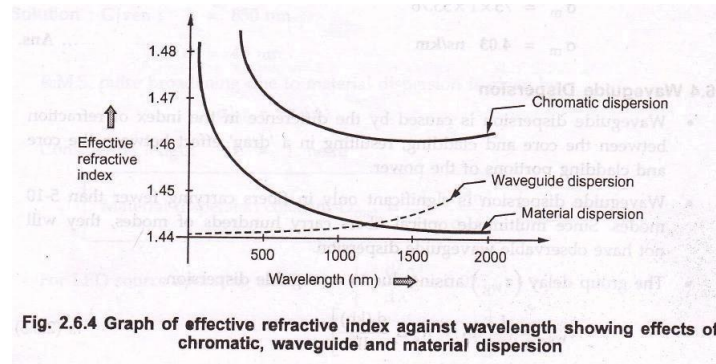

Fig. 2.6.4 Graph of effective refractive index against wavelength showing effects of chromatic, waveguide and material dispersion

Material dispersion and waveguide dispersion effects vary in opposite senses as the wavelength increased, but at an optimum wavelength around 1300 nm, two effects almost cancel each other and chromatic dispersion is at minimum. Attenuation is therefore also at minimum and makes 1300 nm a highly attractive operating wavelength.

## Modal Dispersion

As only a certain number of modes can propagate down the fiber, each of these modes carries the modulation signal and each one is incident on the boundary at a different angle, they will each have their own individual propagation times. The net effect is spreading of pulse, this form of dispersion is called modal dispersion.

- Modal dispersion takes place in multimode fibers. It is moderately present

in graded index fibers and almost eliminated in single mode step index fibers.

- Modal dispersion is given by,

$$\Delta t_{\text{modal}} = \frac{n_1 Z}{c} \left( \frac{\Delta}{1 - \Delta} \right)$$

where  $\Delta t_{\text{modal}}$  = Dispersion

$n_1$  = Core  
refractive index

$Z$  = Total fiber  
length

$c$  = Velocity of light in air

$\Delta$  = Fractional refractive index  $\left( \frac{n_1 - n_2}{n_1} \right)$

Putting in above equation  $\Delta = \frac{(NA^2)Z}{2n_1 c}$

$$\Delta t_{\text{modal}} = \frac{(NA^2)Z}{2n_1 c}$$

$$t_{r \text{ mod}} = 0.44 (\Delta t_{\text{modal}}) \pi r^2$$

**Example 2.6.3 :** For a single mode fiber  $n_2 = 1.48$  and  $\Delta = 0.2\%$  operating at  $\lambda = 1320$

nm, compute the waveguide dispersion if  $V \cdot \frac{d^2(Vb)}{dv^2} = 0.26$ .

Solution :

$$n_2 = 1.48$$

$$\Delta = 0.2$$

$$\lambda = 1320 \text{ nm}$$

Waveguide dispersion is given by,

$$D_{wg}(\lambda) = \frac{-n_2 \Delta}{3 \times 10^5 \times \lambda} \left[ V \frac{d^2(Vb)}{dv^2} \right]$$

$$= \frac{-1.48 \times 0.2}{3 \times 10^5 \times 1320} [0.26]$$

$$= -1.943 \text{ picosec/nm} \cdot$$

km.

Higher Order Dispersion

S.

$$S = \frac{dD}{d\lambda}$$

Higher order dispersive effective effects are governed by dispersion slope

where,  $D$  is total dispersion

Also,

$$S = \left(\frac{2\pi c}{\lambda^2}\right)^2 \beta_3 + \left(\frac{4\pi c}{\lambda^3}\right) \beta_2 \text{ where,}$$

$\beta_2$  and  $\beta_3$  are second and third order dispersion parameters.

- Dispersion slope  $S$  plays an important role in designing WDM system

### **Dispersion Induced Limitations**

- The extent of pulse broadening depends on the width and the shape of input pulses. The pulse broadening is studied with the help of wave equation.

### **Basic Propagation Equation**

- The basic propagation equation which governs pulse evolution in a single mode fiber is given by,

$$\frac{\partial A}{\partial z} + \beta_1 \frac{\partial A}{\partial t} + \frac{i\beta_2}{2} \frac{\partial^2 A}{\partial t^2} - \frac{\beta_3}{6} \frac{\partial^3 A}{\partial t^3} = 0$$

where,

$\beta_1$ ,  $\beta_2$  and  $\beta_3$  are different dispersion parameters.

### Chirped Gaussian Pulses

- A pulse is said to be chirped if its carrier frequency changes with time.
- For a Gaussian spectrum having spectral width  $\sigma_\omega$ , the pulse broadening factor is given by,

$$\frac{\sigma^2}{\sigma_0^2} = \left(1 + \frac{C\beta_2 L}{2\sigma_0^2}\right)^2 + (1 + V_\omega^2) \left(\frac{\beta_2 L}{2\sigma_0^2}\right)^2 + (1 + C + V_\omega^2)^2 \left(\frac{\beta_3 L}{4\sqrt{2}\sigma_0^3}\right)^2 \pi r^2$$

where,  $V_\omega = 2\sigma_\omega \sigma_0$

### Limitations of Bit Rate

- The limiting bit rate is given by,

$$4B \sigma \leq 1$$

- The condition relating bit rate-distance product (BL) and dispersion (D) is given

$$BL |S| \sigma_{\lambda}^2 \leq \frac{1}{\sqrt{8}}$$

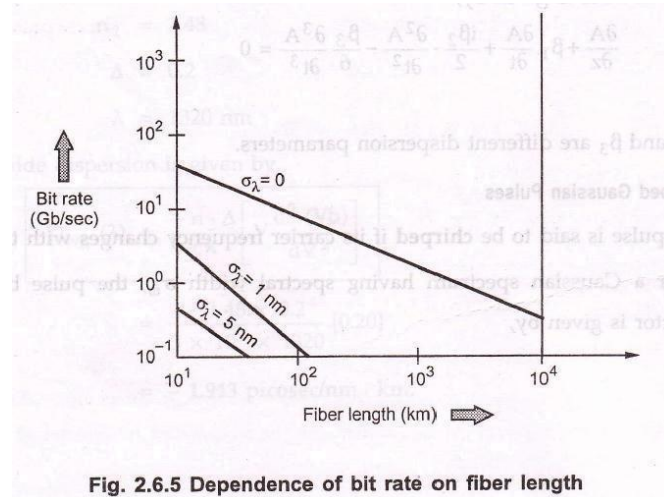

Fig. 2.6.5 Dependence of bit rate on fiber length

where, S is dispersion slope. Limiting bit rate a single mode fibers as a function of fiber length for  $\sigma_{\lambda} = 0$ , 1 and 5nm is shown in fig. 2.6.5.

## Polarization Mode Dispersion (PMD)

- Different frequency component of a pulse acquires different polarization state (such as linear polarization and circular polarization). This results in pulse broadening is known as **polarization mode dispersion (PMD)**.
- PMD is the limiting factor for optical communication system at high data rates. The effects of PMD must be compensated.

## Pulse Broadening in GI Fibers



- The core refractive index varies radially in case of graded index fibers, hence it supports multimode propagation with a low intermodal delay distortion and high data rate over long distance is possible. The higher order modes travelling in outer regions of the core, will travel faster than the lower order modes travelling in high refractive index region. If the index profile is carefully controlled, then the transit times of the individual modes will be identical, so eliminating modal dispersion.
  - The r.m.s pulse broadening is given as:

$$\sigma = \left( \sigma_{\text{intermodal}}^2 + \sigma_{\text{intermodal}}^2 \right)^{1/2} \quad \dots (2.7.1)$$

where,

$\sigma_{\text{intermodal}}$  – R.M.S pulse width due to intermodal delay distortion.

$\sigma_{\text{intermodal}}$  – R.M.S pulse width resulting from pulse broadening within each mode.

- The intermodal delay and pulse broadening are related by expression given by Personick.

$$\sigma_{\text{intermodal}} = \left( \langle \tau_g^2 \rangle - \langle \tau_g \rangle^2 \right)^{1/2} \quad \dots (2.7.2)$$

Where  $\tau_g$  is group delay.

From this the expression for intermodal pulse broadening is given as:

$$\sigma_{\text{intermodal}} = \frac{LN_1\Delta}{2c} \cdot \frac{\alpha}{\alpha+1} \left( \frac{\alpha+2}{3\alpha+2} \right)^{1/2} \times$$

$$\left[ c_1^2 + \frac{4c_1c_2(\alpha+1)}{2\alpha+1} + \frac{16\Delta^2c_2^2(\alpha+1)^2}{(5\alpha+2)(3\alpha+2)} \right]^{1/2}$$

... (2.7.3)

$$c_1 = \frac{\alpha-2-E}{\alpha+2} \text{ and } c_2 = \frac{3\alpha-2-2c}{2(\alpha+2)}$$

- The intramodal pulse broadening is given as :

$$\sigma_{\text{intramodal}}^2 = \left( \frac{\sigma\lambda}{\lambda} \right)^2 \left\langle \left( \lambda \frac{d\tau_g}{d\lambda} \right)^2 \right\rangle \quad \dots (2.7.4)$$

Where  $\sigma\lambda$  is spectral width of optical source.

Solving the expression gives :

$$\sigma_{\text{intramodal}}^2 = \frac{L}{c} \cdot \frac{\sigma\lambda}{\lambda} \left[ \left( -\lambda^2 \frac{d^2n_1}{d\lambda^2} \right)^2 - N_1c_1\Delta \right]$$

$$\left( 2\lambda^2 \frac{d^2 n_z}{d\lambda^2} \cdot \frac{\alpha}{\alpha+1} - N_1 c_1 \Delta \frac{4\alpha^2}{(\alpha+2)(3\alpha+2)} \right)^{1/2}$$

## Mode Coupling

After certain initial length, the pulse distortion increases less rapidly because of mode coupling. The energy from one mode is coupled to other modes because of Structural imperfections, Fiber diameter variations, Refractive index variations, Microbends in cable. Due to the mode coupling, average propagation delay become less and intermodal distortion reduces. Suppose certain initial coupling length =  $L_c$ , mode coupling length, over  $L_c = Z$ . Additional loss associated with mode coupling =  $h$  (dB/ km). Therefore the excess attenuation resulting from mode coupling =  $hZ$ . The improvement in pulse spreading by mode coupling is given as :

$$hZ \left( \frac{\sigma_c}{\sigma_0} \right) = C$$

where,  $C$  is constant independent of all dimensional quantities and refractive indices.  $\sigma_c$  is pulse broadening under mode coupling.  $\sigma_0$  is pulse broadening in absence of mode coupling. For long fiber length's the effect of mode coupling on pulse distortion is significant. For a graded index fiber, the effect of distance on pulse broadening for various coupling losses are shown

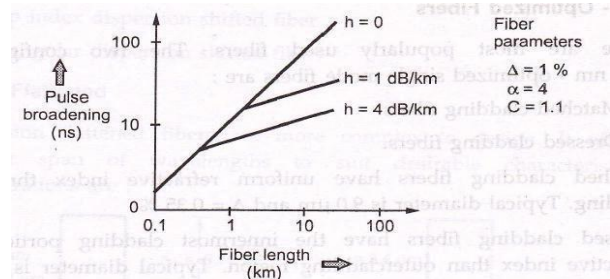

Fig. 2.8.1 Mode coupling effects on pulse broadening

## **Design Optimization**

Features of single mode fibers are : Longer life, Low attenuation ,Signal Transfer quality is good, Modal noise is absent,Largest BW-distance product.

Basic design – optimization includes the following : Dispersion,Mode field,Diameter,bending loss, Refractive index profile,Cut-off wavelength.

## **Refractive Index Profile**

Dispersion of single mode silica fiber is lowest at 1300 nm while its attenuation is minimum at 1550 nm. For archiving maximum transmission distance the dispersion null should be at the wavelength of minimum attenuation. The waveguide dispersion is easier to control than the material dispersion. Therefore a variety of core-cladding refractive.

## **1300 nm – Optimized Fibers**

These are most popularly used fibers. The two configurations of 1300 nm – optimized single mode fibers are

- Matched cladding fibers.
- Dressed cladding fibers.

Matched cladding fibers have uniform refractive index throughout its cladding. Typical diameter is  $9.0\ \mu\text{m}$  and  $\Delta = 0.35\ \%$ .

Dressed cladding fibers have the innermost cladding portion has low refractive index than outcladding region. Typical diameter is  $8.4\ \mu\text{m}$  and  $\Delta_1 = 0.25\ \%$ ,  $\Delta_2 = 0.12\ \%$ .

Fig 2.9.1 shows both types of fibers.

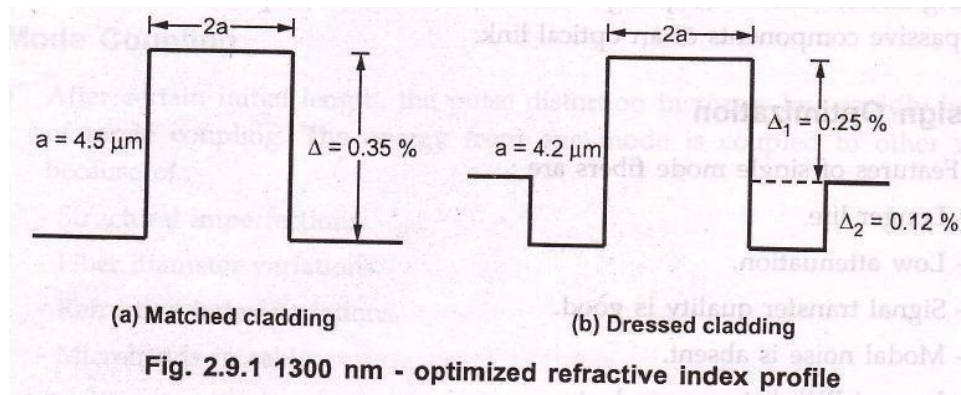

## Dispersion Shifted Fibers

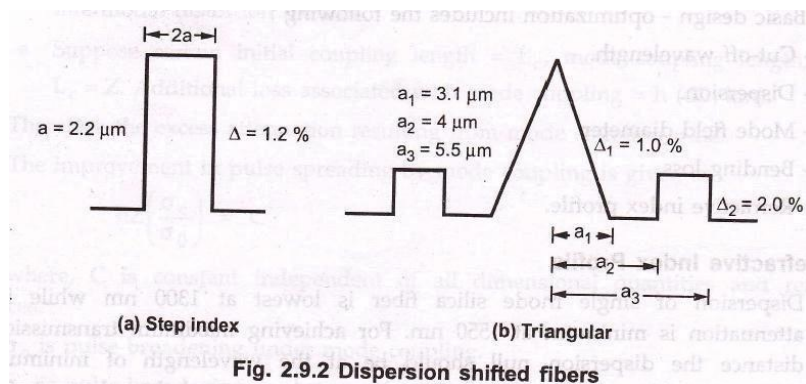

- The addition of wavelength and material dispersion can shift the zero dispersion point of longer wavelength. Two configurations of dispersion shifted fibers are

## Dispersion Flattened

Dispersion flattened fibers are more complex to design. It offers much broader span of wavelengths to suit desirable characteristics. Two configurations are :

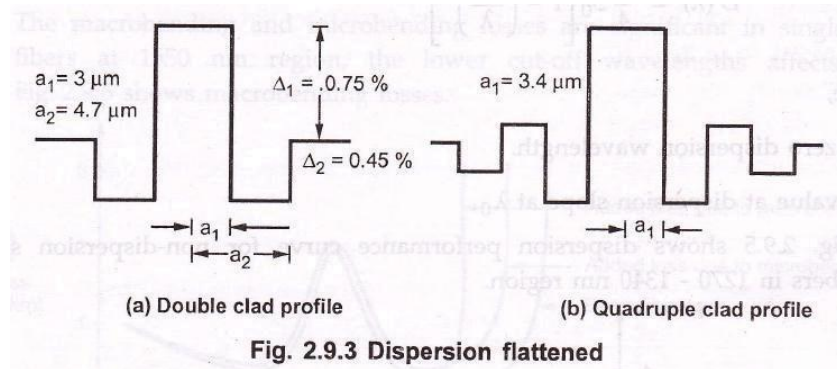

- Fig 2.9.4 shows total resultant dispersion.

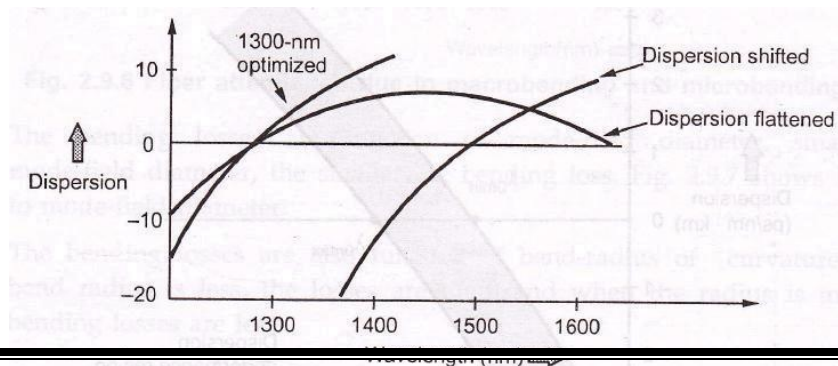

## Dispersion Calculations

The total dispersion consists of material and waveguide dispersions. The resultant intermodal dispersion is given as,

$$D(\lambda) = \frac{d\tau}{d\lambda}$$

where,  $\tau$  is group delay per unit length of fiber.

The broadening  $\sigma$  of an optical pulse is given

$$\sigma = D(\lambda) L \sigma_\lambda$$

where,  $\sigma_\lambda$  is half power spectral width of source.

As the dispersion varies with wavelength and fiber type. Different formulae are used to calculate dispersions for variety of fiber at different wavelength. For a non –

$$D(\lambda) = \frac{\lambda}{4} S_0 \left[ 1 - \left( \frac{\lambda_0}{\lambda} \right)^4 \right]$$

dispersion shifted fiber between 1270 nm to 1340 nm wavelength, the expression for dispersion is given as :

where,  $\lambda_0$  is zero dispersion wavelength.

$S_0$  is value at dispersion slop at  $\lambda_0$ .

Fig 2.9.5 shows dispersion performance curve for non-dispersion shifted fibers in 1270 – 1340 nm region.

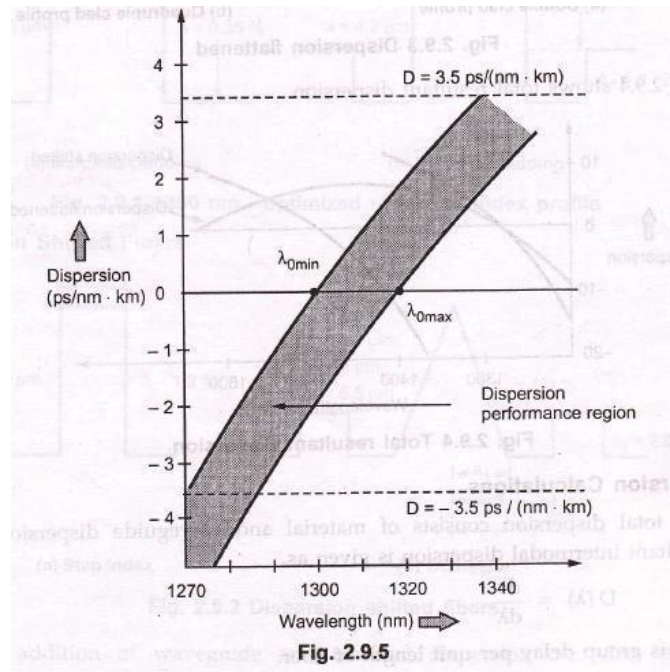

Maximum dispersion specified as  $3.5 \text{ ps}/(\text{nm} \cdot \text{km})$  marked as dotted line in Fig. 2.9.5.

### The cut-off frequency of an optical fiber

The cut-off frequency of an optical fiber is determined not only by the fiber itself (modal dispersion in case of multimode fibers and waveguide dispersion in case of single mode fibers) but also by the amount of material dispersion caused by the spectral width of transmitter.



## Bending Loss Limitations

The macrobending and microbending losses are significant in single mode fibers at 1550 nm region, the lower cut-off wavelengths affects more. Fig. 2.9.6 shows macrobending losses.

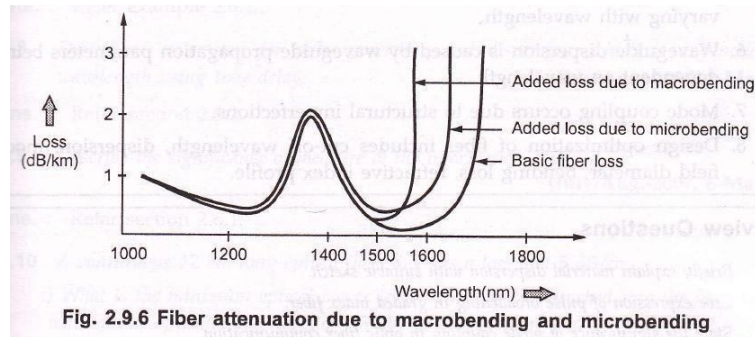

The bending losses are function of mode-field diameter, smaller the mode-field diameter, the smaller the bending loss. Fig. 2.9.7 shows loss due to mode-field diameter. The bending losses are also function of bend-radius of curvature. If the bend radius is less, the losses are more (dB/km) and when the radius is more, the bending losses are less.

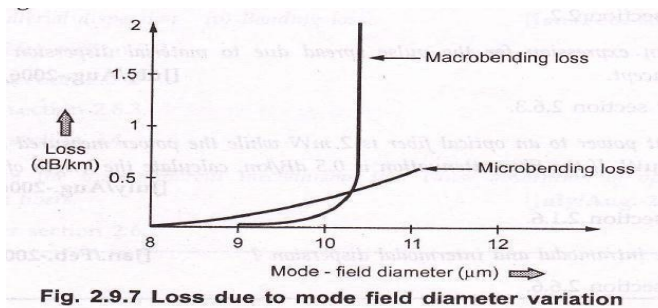

## Optical fiber connectors

An optical fiber connector terminates the end of an optical fiber, and enables quicker connection and disconnection than splicing. The connectors mechanically couple and align the cores of fibers so light can pass. Better connectors lose very little light due to reflection or misalignment of the fibers. In all, about 100 different types of fiber optic connectors have been introduced to the market.

An optical fiber connector is a flexible device that connects fiber cables requiring a quick connection and disconnection. Optical fibers terminate fiber-optic connections to fiber equipment or join two fiber connections without splicing. Hundreds of optical fiber connector types are available, but the key differentiator is defined by the mechanical coupling techniques and dimensions. Optical fiber connectors ensure stable connections, as they ensure the fiber ends are optically smooth and the end-to-end positions are properly aligned.

An optical fiber connector is also known as a fiber optic connector. 1980s. Most fiber connectors are spring loaded.

The main components of an optical fiber connector are a ferrule, sub-assembly body, cable, stress relief boot and connector housing. The ferrule is mostly made of hardened material like stainless steel and tungsten carbide, and it ensures the alignment during connector mating. The connector body holds the ferrule and the coupling device serves the purpose of male-female configuration

The fiber types for fiber optic connectors are categorized into simplex, duplex and multiple fiber connectors. A simplex connector has one fiber terminated in the connector, whereas duplex has two fibers terminated in the connector. Multiple fiber connectors can have two or more fibers terminated in the connector. Optical fiber connectors are dissimilar to other electronic connectors in that they do not have a jack and plug design. Instead they make use of the fiber mating sleeve for connection purposes.

Common optical fiber connectors include biconic, D4, ESCON, FC, FDDI, LC and SC.

- Biconic connectors use precision tapered ends to have low insertion loss.
- D4 connectors have a keyed body for easy intermateability.
- ESCON connectors are commonly used to connect from a wall outlet to a device.

- FC connector (fixed connection connector) is used for single-mode fibers and high-speed communication links.
- FDDI connector is a duplex connector which makes use of a fixed shroud.
- LC connector (local connection connector) has the benefit of small-form-factor optical transmitter/receiver assemblies and is largely used in private and public networks.
- SC connector (subscriber connector) is used in simplex and multiple applications and is best suited for high-density applications.

In fiber-optic communication, a single-mode optical fiber (SMF) is an optical fiber designed to carry only a single mode of light - the transverse mode. Modes are the possible solutions of the Helmholtz equation for waves, which is obtained by combining Maxwell's equations and the boundary conditions. These modes define the way the wave travels through space, i.e. how the wave is distributed in space. Waves can have the same mode but have different frequencies. This is the case in single-mode fibers, where we can have waves with different frequencies, but of the same mode, which means that they are distributed in space in the same way, and that gives us a single ray of light. Although the ray travels parallel to the length of the fiber, it is often called transverse mode since its electromagnetic oscillations occur perpendicular (transverse) to the length of the fiber. The 2009 Nobel Prize in Physics was awarded to Charles K. Kao for his theoretical work on the single-mode optical fiber.<sup>[1]</sup> The standard G.652 defines the most widely used form of single-mode optical fiber.<sup>[2]</sup>

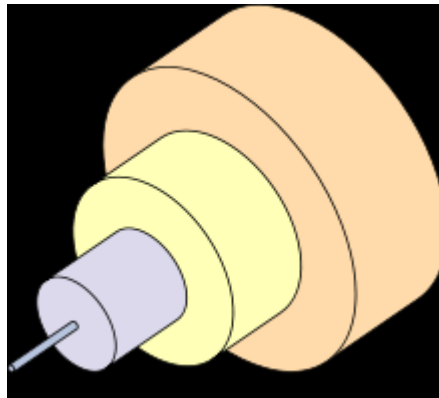

The structure of a typical single-mode fiber.

1. Core 8 -9  $\mu\text{m}$  diameter
2. Cladding 125  $\mu\text{m}$  dia.
3. Buffer 250  $\mu\text{m}$  dia.
4. Jacket 900  $\mu\text{m}$  dia.

Like multi-mode optical fibers, single-mode fibers do exhibit modal dispersion resulting from multiple spatial modes but with narrower modal dispersion.<sup>[citation needed]</sup> Single-mode fibers are therefore better at retaining the fidelity of each light pulse over longer distances than multi-mode fibers. For these reasons, single-mode fibers can have a higher bandwidth than multi-mode fibers. Equipment for single-mode fiber is more expensive than equipment for multi-mode optical fiber, but the single-mode fiber itself is usually cheaper in bulk.

Cross section of a single-mode optical fiber patch cord end, taken with a Fiberscope. The round circle is the cladding, 125 microns in diameter. Debris is visible as a streak on the cross-section, and glows due to the illumination.

A typical single-mode optical fiber has a core diameter between 8 and 10.5  $\mu\text{m}$ <sup>[6]</sup> and a cladding diameter of 125  $\mu\text{m}$ . There are a number of special types of single-mode optical fiber which have been chemically or physically altered to give special properties, such as dispersion-shifted fiber and nonzero dispersion-shifted fiber. Data rates are limited by polarization mode dispersion and chromatic dispersion. As of 2005, data rates of up to 10 gigabits per second were possible at distances of over 80 km (50 mi) with commercially available transceivers (Xenpak). By using optical amplifiers and dispersion-compensating devices, state-of-the-art DWDM optical systems can span thousands of kilometers at 10 Gbit/s, and several hundred kilometers at 40 Gbit/s.<sup>[citation needed]</sup>

The lowest-order bounds mode is ascertained for the wavelength of interest by solving Maxwell's equations for the boundary conditions imposed by the fiber, which are determined by the core diameter and the refractive indices of the core and cladding. The solution of Maxwell's equations for the lowest order bound mode will permit a pair of orthogonally polarized fields in the fiber, and this is the usual case in a communication fiber.

In step-index guides, single-mode operation occurs when the normalized frequency,  $V$ , is less than or equal to 2.405. For power-law profiles, single-mode operation occurs for a normalized frequency,  $V$ , less than approximately where  $g$  is the profile parameter.

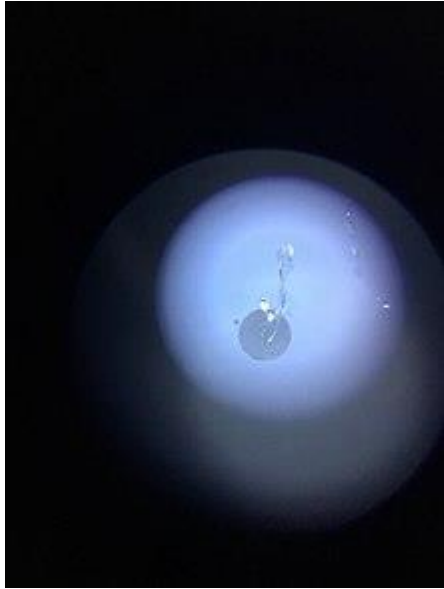

Cross section of a single-mode optical fiber patch cord end, taken with a Fiberscope. The round circle is the cladding, 125 microns in diameter. Debris is visible as a streak on the cross-section, and glows due to the illumination.

In practice, the orthogonal polarizations may not be associated with degenerate modes. OS1 and OS2 are standard single-mode optical fiber used with wavelengths 1310 nm and 1550 nm (size 9/125  $\mu\text{m}$ ) with a maximum attenuation of 1 dB/km (OS1) and 0.4 dB/km (OS2). OS1 is defined in ISO/IEC 11801,<sup>[7]</sup> and OS2 is defined in ISO/IEC 24702.

### **Optical fiber connectors**

Optical fiber connectors are used to join optical fibers where a connect/disconnect capability is required. The basic connector unit is a connector assembly. A connector assembly consists of an adapter and two connector plugs. Due to the sophisticated polishing and tuning

procedures that may be incorporated into optical connector manufacturing, connectors are generally assembled onto optical fiber in a supplier's manufacturing facility. However, the assembly and polishing operations involved can be performed in the field, for example to make cross-connect jumpers to size.

Optical fiber connectors are used in telephone company central offices, at installations on customer premises, and in outside plant applications. Their uses include:

- Making the connection between equipment and the telephone plant in the central office
- Connecting fibers to remote and outside plant electronics such as Optical Network Units (ONUs) and Digital Loop Carrier (DLC) systems
- Optical cross connects in the central office
- Patching panels in the outside plant to provide architectural flexibility and to interconnect fibers belonging to different service providers
- Connecting couplers, splitters, and Wavelength Division Multiplexers (WDMs) to optical fibers
- Connecting optical test equipment to fibers for testing and maintenance.

Outside plant applications may involve locating connectors underground in subsurface enclosures that may be subject to flooding, on outdoor walls, or on utility poles. The closures that enclose them may be hermetic, or may be "free-breathing." Hermetic closures will prevent the connectors within being subjected to temperature swings unless they are breached. Free-breathing enclosures will subject them to temperature and humidity swings, and possibly to condensation and biological action from airborne bacteria, insects, etc. Connectors in the underground plant may be subjected to groundwater immersion if the closures containing them are breached or improperly assembled.

The latest industry requirements for optical fiber connectors are in Telcordia GR-326, *Generic Requirements for Singlemode Optical Connectors and Jumper Assemblies*. A *multi-fiber* optical connector is designed to simultaneously join multiple optical fibers together, with each optical fiber being joined to only one other optical fiber. The last part of the definition is included so as not to confuse multi-fiber connectors with a branching component, such as a coupler. The latter joins one optical fiber to two or more other optical fibers. Multi-fiber

optical connectors are designed to be used wherever quick and/or repetitive connects and disconnects of a group of fibers are needed. Applications include telecommunications companies' Central Offices (COs), installations on customer premises, and Outside Plant (OSP) applications. The multi-fiber optical connector can be used in the creation of a low-cost switch for use in fiber optical testing. Another application is in cables delivered to a user with pre-terminated multi-fiber jumpers. This would reduce the need for field splicing, which could greatly reduce the number of hours necessary for placing an optical fiber cable in a telecommunications network. This, in turn, would result in savings for the installer of such cable.

The return loss RL is a measure of the portion of light that is reflected back to the source at the junction. It is expressed in decibel. The higher the RL value in decibels, the lower are the reflections. Typical RL values lie between 35 and 50 dB for PC, 60 to 90 dB for APC and 20 to 40 dB for multimode fibres.

In the early days of fibre-optic plug-in connectors, the abutting endfaces were polished to an angle of  $90^\circ$  to the fibre axis, while current standards require PC (Physical Contact) polishing or APC (Angled Physical Contact) polishing. The term HRL (High Return Loss) is frequently used, but it has the same meaning as APC.

In PC polishing, the ferrule is polished to a convex end to ensure that the fibre cores touch at their highest point. This reduces the occurrence of reflections at the junction. A further improvement in return loss is achieved by using the APC polishing technique. Here, the convex end surfaces of the ferrules are polished to an angle ( $8^\circ$ ) relative to the fibre axis. SC connectors are also sold with a  $9^\circ$  angle. They possess IL and RL values identical to  $8^\circ$  versions, and for this reason they have not established themselves worldwide.

## **Return Loss**

In optics (particularly in fiberoptics) a loss that takes place at discontinuities of refractive index, especially at an air-glass interface such as a fiber endface. At those interfaces, a fraction of the optical signal is reflected back toward the source. This reflection phenomenon is also called "**Fresnel reflection loss**," or simply "**Fresnel loss**."

Fiber optic transmission systems use lasers to transmit signals over optical fiber, and a high optical return loss (ORL) can cause the laser to stop transmitting correctly. The measurement of ORL is becoming more important in the characterization of optical networks as the use of wavelength-division multiplexing increases. These systems use lasers that have a lower tolerance for ORL, and introduce elements into the network that are located in close proximity to the laser.

### **Definition of Return Loss**

In technical terms, RL is the ratio of the light reflected back from a device under test,  $P_{out}$ , to the light launched into that device,  $P_{in}$ , usually expressed as a negative number in dB.

$$RL = 10 \log_{10}(P_{out}/P_{in})$$

where  $P_{out}$  is the reflected power and  $P_{in}$  is the incident, or input, power.

Sources of loss include reflections and scattering along the fiber network. A typical RL value for an Angled Physical Contact (APC) connector is about -55dB, while the RL from an open flat polish to air is typically about -14dB. High RL is a large concern in high bitrate digital or analog single mode systems and is also an indication of a potential failure point, or compromise, in any optical network.



## UNIT III

### OPTICAL SOURCES

#### 3.1 Optical Sources

Optical transmitter converts electrical input signal into corresponding optical signal. The optical signal is then launched into the fiber. Optical source is the major component in an optical transmitter. Popularly used optical transmitters are Light Emitting Diode (LED) and semiconductor

#### **Laser Diodes (LD)**

#### **Characteristics of Light Source of Communication**

To be useful in an optical link, a light source needs the following characteristics

It must be possible to operate the device continuously at a variety of temperatures for many years.

- It must be possible to modulate the light output over a wide range of modulating frequencies. For fiber links, the wavelength of the output should coincide with one of transmission windows for the fiber type used.
- To couple large amount of power into an optical fiber, the emitting area should be small.
- To reduce material dispersion in an optical fiber link, the output spectrum should be narrow.
- The power requirement for its operation must be low.
- The light source must be compatible with the modern solid state devices.

- The optical output power must be directly modulated by varying the input current to the device.
- Better linearity of prevent harmonics and intermodulation distortion.
- High coupling efficiency.
- High optical output power.
- High reliability.
- Low weight and low cost.

Two types of light sources used in fiber optics are light emitting diodes (LEDs) and laser diodes (LDs).

## **Light Emitting Diodes(LEDs)**

### **p-n Junction**

Conventional p-n junction is called as **homojunction** as same semiconductor material is used on both sides junction. The electron-hole recombination occurs in relatively layer = 10  $\mu\text{m}$ . As the carriers are not confined to the immediate vicinity of junction, hence high current densities can not be realized.

The carrier confinement problem can be resolved by sandwiching a thin layer ( = 0.1  $\mu\text{m}$ ) between p-type and n-type layers. The middle layer may or may not be doped. The carrier confinement occurs due to bandgap discontinuity of the junction. Such a junction is called heterojunction and the device is called double heterostructure.

In any optical communication system when the requirements is 1. Bit rate f 100-2—Mb/sec.

2. Optical power in tens of micro watts, LEDs are best suitable optical source.

## LED Structures

### Heterojunctions:

- A heterojunction is an interface between two adjoining single crystal semiconductors with different bandgap.
- Heterojunctions are of two types, Isotype (n-n or p-p) or Antisotype (p-n).

### Double Heterojunctions (DH):

In order to achieve efficient confinement of emitted radiation double heterojunctions are used in LED structure. A heterojunction is a junction formed by dissimilar semiconductors. Double heterojunction (DH) is formed by two different semiconductors on each side of active region. Fig. 3.1.1 shows double heterojunction (DH) light emitter.

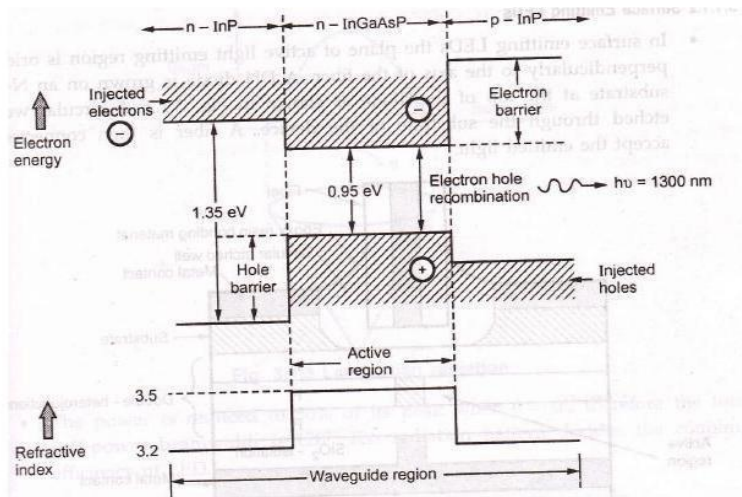

The crosshatched regions represent the energy levels of free charge. Recombination occurs only in active In GaAsP layer. The two materials have different band gap energies and different refractive indices. The changes in band gap energies create potential barrier for both holes and electrons. The free charges can recombine only in narrow, well defined active layer side.

A double heterojunction (DH) structure will confine both hole and electrons to a narrow active layer. Under forward bias, there will be a large number of carriers injected into active region where they are efficiently confined. Carrier recombination occurs in small active region so leading to an efficient device. Another advantage DH structure is that the active region has a higher refractive index than the materials on either side, hence light emission occurs in an optical waveguide, which serves to narrow the output beam.

### **LED configurations**

At present there are two main types of LED used in optical fiber links

Surface emitting LED

Edge emitting LED.

Both devices used a DH structure to constrain the carriers and the light to an active layer.

### **Surface Emitting LEDs**

In surface emitting LEDs the plane of active light emitting region is oriented perpendicularly to the axis of the fiber. A DH diode is grown on an N-type substrate at the top of the diode as shown in Fig. 3.1.2. A circular well is etched through the substrate of the device. A fiber is then connected to accept the emitted

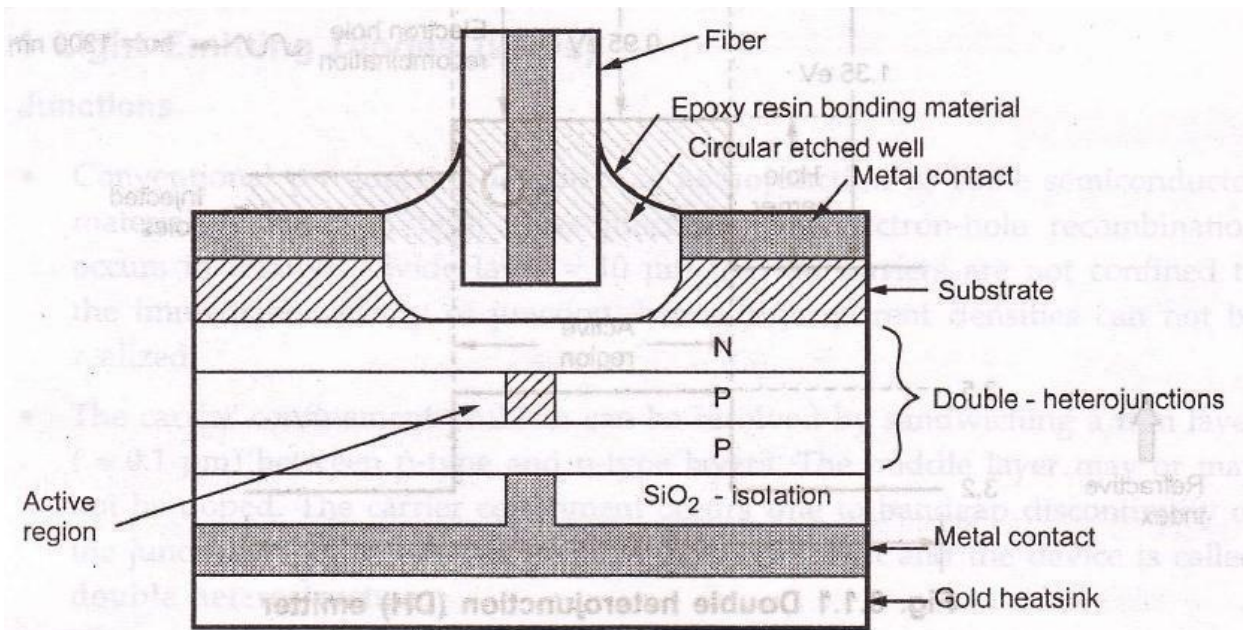

**Fig. 3.1.2 Cross-section through a typical surface emitting LED**

At the back of device is a gold heat sink. The current flows through the p-type material and forms the small circular active region resulting in the intense  $\pi$  beam of light.

Diameter of circular active area =  $50\ \mu\text{m}$

Thickness of circular active area =  $2.5\ \mu\text{m}$

Current density =  $2000\ \text{A}/\text{cm}^2$  half-power

Emission pattern = Isotropic,  $120^\circ$  beamwidth.

The isotropic emission pattern from surface emitting LED is of Lambertian pattern. In Lambertian pattern, the emitting surface is uniformly bright, but its projected area diminishes as  $\cos \theta$ , where  $\theta$  is the angle between the viewing direction and the normal to the surface as shown in Fig. 3.1.3. The beam intensity is maximum along the normal.

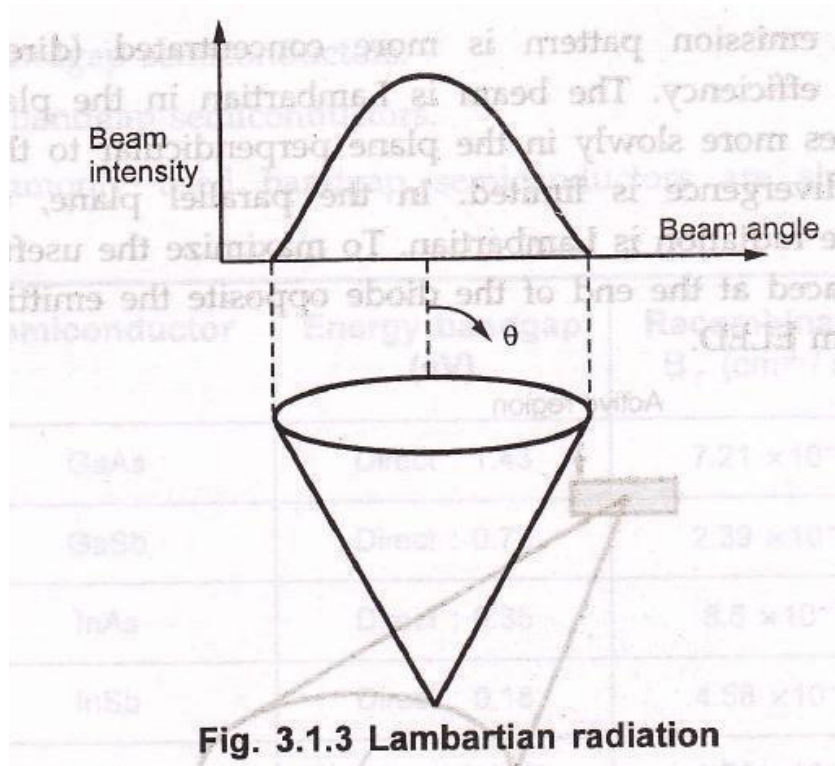

The power is reduced to 50% of its peak when  $\theta = 60^\circ$ , therefore the total half-power beamwidth is  $120^\circ$ . The radiation pattern decides the coupling efficiency of LED.

## Edge Emitting LEDs (ELEDs)

In order to reduce the losses caused by absorption in the active layer and to make the beam more directional, the light is collected from the edge of the LED. Such a device is known as edge emitting LED or ELED.

It consists of an active junction region which is the source of incoherent light and two guiding layers. The refractive index of guiding layers is lower than active region but higher than outer surrounding material. Thus a waveguide channel is formed and optical radiation is directed into the fiber. Fig. 3.1.4 shows structure of LED

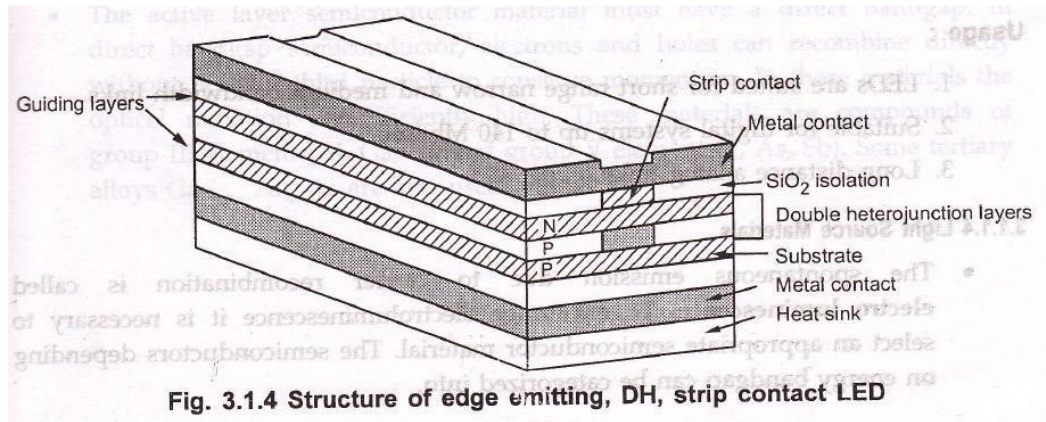

Edge emitter's emission pattern is more concentrated (directional) providing improved coupling efficiency. The beam is Lambertian in the plane parallel to the junction but diverges more slowly in the plane perpendicular to the junction. In this plane, the beam divergence is limited. In the parallel plane, there is no beam confinement and the radiation is Lambertian. To maximize the useful output power, a reflector may be placed at the end of the diode opposite the emitting edge. Fig. 3.1.5 shows radiation from ELED.

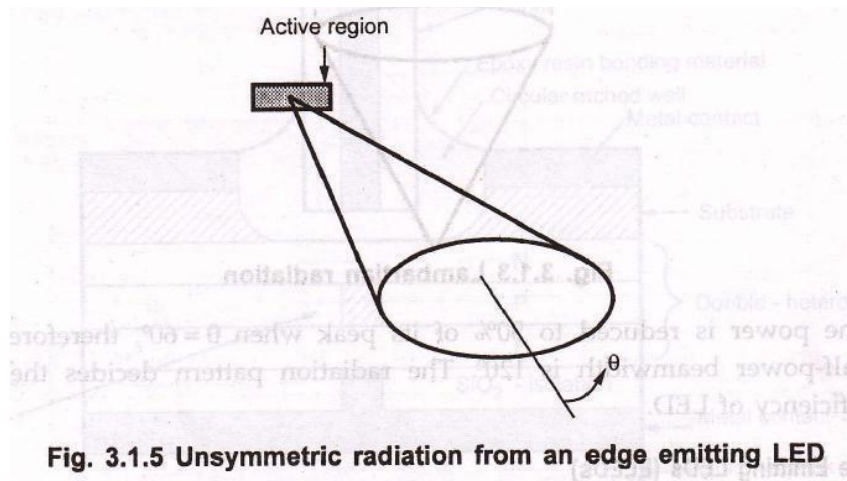

**Fig. 3.1.5 Unsymmetric radiation from an edge emitting LED**

### Features of ELED:

- Linear relationship between optical output and current.
- Spectral width is 25 to 400 nm for  $\lambda = 0.8 - 0.9 \mu\text{m}$ .
- Modulation bandwidth is much large.
- Not affected by catastrophic gradation mechanisms hence are more reliable.
- ELEDs have better coupling efficiency than surface emitter.
- ELEDs are temperature sensitive.

### Usage :

1. LEDs are suited for short range narrow and medium bandwidth links.
2. Suitable for digital systems up to 140 Mb/sec.
3. Long distance analog links



## Light Source Materials

The spontaneous emission due to carrier recombination is called electro luminescence. To encourage electroluminescence it is necessary to select as appropriate semiconductor material. The semiconductors depending on energy bandgap can be categorized into

Direct bandgap semiconductors.

Indirect bandgap semiconductors.

Some commonly used bandgap semiconductors are shown in following table 3.1.1

Semiconductor	Energy bandgap (eV)	Recombination Br (cm <sup>3</sup> / sec)
GaAs	Direct : 1.43	7.21 x 10 <sup>-10</sup>
GaAs	Direct : 0.73	2.39 x 10 <sup>-10</sup>
InAs	Direct : 0.35	8.5 x 10 <sup>-11</sup>
InSb	Direct : 0.18	4.58 x 10 <sup>-11</sup>
Si	Indirect : 1.12	1.79 x 10 <sup>-15</sup>
Ge	Indirect : 0.67	5.25 x 10 <sup>-14</sup>
GaP	Indirect : 2.26	5.37 x 10 <sup>-14</sup>

**Table 3.1.1 Semiconductor material for optical sources**

Direct bandgap semiconductors are most useful for this purpose. In direct bandgap semiconductors the electrons and holes on either side of bandgap have same value of  $\hbar$  crystal momentum. Hence direct recombination is possible. The recombination occurs within 10<sup>-8</sup> to 10<sup>-10</sup> sec.

In indirect bandgap semiconductors, the maximum and minimum energies occur at different values of crystal momentum. The recombination in these semiconductors is quite slow i.e.  $10^{-2}$  and  $10^{-3}$  sec.

The active layer semiconductor material must have a direct bandgap. In direct bandgap semiconductor, electrons and holes can recombine directly without need of third particle to conserve momentum. In these materials the optical radiation is sufficiently high. These materials are compounds of group III elements (Al, Ga, In) and group V element (P, As, Sb). Some tertiary allos  $Ga_{1-x}Al_xAs$  are also used.

Emission spectrum of  $Ga_{1-x}Al_xAs$  LED is shown in Fig. 3.1.6.

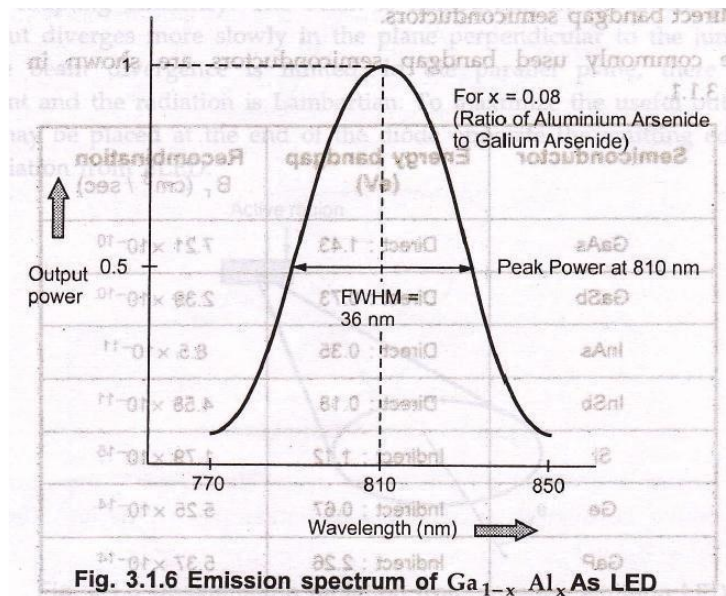

The peak output power is obtained at 810 nm. The width of emission spectrum at half power (0.5) is referred as full width half maximum (FWHM) spectral width. For the

given LED FWHM is 36 nm.

The fundamental quantum mechanical relationship between gap energy E and frequency

v is given as

$$E = hv$$

$$E = h \frac{c}{\lambda}$$

$$\lambda = \frac{hc}{E}$$

where, energy (E) is in joules and wavelength ( $\lambda$ ) is in meters. Expressing the gap energy ( $E_g$ ) in electron volts and wavelength ( $\lambda$ ) in micrometers for this application.

$$\lambda(\mu\text{m}) = \frac{1.24}{E_g(\text{eV})}$$

Different materials and alloys have different band gap energies

The bandgap energy ( $E_g$ ) can be controlled by two compositional parameters x and y, within direct bandgap region. The quaternary alloy  $\text{In}_{1-x}\text{Ga}_x\text{As}_y\text{P}_{1-y}$  is the principal material used in such LEDs. Two expressions relating  $E_g$  and x,y are –

$$E_g = 1.424 + 1.266x + 0.266x^2$$

$$E_g = 1.35 - 0.72y + 0.12y^2$$

**Example 3.1.1** : Compute the emitted wavelength from an optical source having  $x = 0.07$ .

**Solution** :  $x = 0.07$

$$E_g = 1.424 + 1.266 x + 0.266 x^2$$

$$E_g = 1.424 + (1.266 \times 0.07) + 0.266 \times (0.07)^2$$

$$E_g = 1.513 \text{ eV}$$

now

$$\lambda = \frac{1.24}{E_g}$$

$$\lambda = \frac{1.24}{1.513}$$

$$\lambda = 0.819 \text{ } \mu\text{m}$$

$$\lambda = \mathbf{0.82 \text{ } \mu\text{m}}$$

**Example 3.1.2** : For an alloy  $\text{In}_{0.74} \text{Ga}_{0.26} \text{As}_{0.57} \text{P}_{0.43}$  to be used in LED. Find the wavelength emitted by this source.

**Solution** : Comparing the alloy with the quaternary alloy composition.  $\text{In}_{1-x} \text{Ga}_x \text{As}_{1-y} \text{P}_y$  it is found that

$$x = 0.26 \text{ and } y = 0.57$$

$$E_g = 1.35 - 0.72 y + 0.12 y^2$$

Using

$$E_g = 1.35 - (0.72 \times 0.57) + 0.12 \times 0.57^2$$

$$E_g = 0.978 \text{ eV}$$

now

$$\lambda = \frac{1.24}{E_g}$$

$$\lambda = \frac{1.24}{0.978}$$

$$\lambda = 1.2671 \text{ } \mu\text{m}$$

$$\lambda = 1.27 \text{ } \mu\text{m}$$

### Quantum Efficiency and Power

The internal quantum efficiency ( $\eta_{int}$ ) is defined as the ratio of radiative recombination rate to the total recombination rate.

$$\eta_{int} = \frac{R_r}{R_r + R_{nr}}$$

Where,

$R_r$  is radiative recombination rate.

$R_{nr}$  is non-radiative recombination rate.

$$\tau_r = \frac{n}{R_r}$$

If  $n$  are the excess carriers, then radiative life time, and non-radiative life time,

$$\tau_{nr} = \frac{n}{R_{nr}}$$

The internal quantum efficiency is given The recombination time of carriers in active region is  $\tau$ . It is also known as bulk recombination life time.

$$\eta_{int} = \frac{1}{1 + \frac{R_{nr}}{R_r}}$$

$$\frac{1}{\tau} = \frac{1}{\tau_r} + \frac{1}{\tau_{nr}}$$

$$\eta_{int} = \frac{1}{1 + \frac{\tau_r}{\tau_{nr}}}$$

Therefore internal quantum efficiency is given as –

$$\eta_{int} = \frac{\tau}{\tau_r}$$

If the current injected into the LED is I and q is electron charge then total number of re combinations per second is –

$$R_r = R_{nr} = \frac{I}{q}$$

$$\eta_{int} = \frac{R_r}{I/q}$$

$$R_r = \eta_{int} \times \frac{I}{q}$$

Optical power generated internally in LED is given as –

$$P_{int} = R_r \cdot h \nu$$

$$P_{int} = \left( \eta_{int} \times \frac{I}{q} \right) \cdot h \nu$$

$$P_{int} = \left( \eta_{int} \times \frac{I}{q} \right) \cdot h \frac{c}{\lambda}$$

$$P_{\text{int}} = \eta_{\text{int}} \cdot \frac{hc I}{q\lambda}$$

Not all internally generated photons will be available from output of device. The external quantum efficiency is used to calculate the emitted power. The external quantum efficiency is defined as the ratio of photons emitted from LED to the number of photons generated internally. It is given by equation

$$\eta_{\text{ext}} = \frac{1}{n(n+1)^2}$$

The optical output power emitted from LED is given as –

$$P = \eta_{\text{ext}} \cdot P_{\text{int}}$$

$$P = \frac{1}{n(n+1)^2} \cdot P_{\text{int}}$$

**Example 3.1.3** : The radiative and non radiative recombination life times of minority carriers in the active region of a double heterojunction LED are 60 nsec and 90 nsec respectively. Determine the total carrier recombination life time and optical power generated internally if the peak emission wavelength is 870 nm and the drive current is 40 mA.

**Solutions:**

**Given :**  $\lambda = 870 \text{ nm} = 0.87 \times 10^{-6} \text{ m}$

$\tau_r = 60 \text{ nsec.}$

$\tau_{nr} = 90 \text{ nsec.}$

$I = 40 \text{ mA} = 0.04 \text{ Amp.}$

i) Total carrier recombination life time:

$$\frac{1}{\tau} = \frac{1}{\tau_r} + \frac{1}{\tau_{nr}}$$

$$\frac{1}{\tau} = \frac{1}{60} + \frac{1}{90}$$

$$\frac{1}{\tau} = \frac{150}{5400}$$

ii) Internal optical power

$$P_{\text{int}} = \eta_{\text{int}} \frac{hc I}{q\lambda}$$

iii)

$$P_{\text{int}} = \left(\frac{\tau}{\tau_r}\right) \left(\frac{hc I}{q\lambda}\right)$$

iv)

$$P_{\text{int}} = \left(\frac{30}{60}\right) \left[\frac{(6.625 \times 10^{-34})(3 \times 10^8) \times 0.04}{(1.602 \times 10^{-19})(0.87 \times 10^{-6})}\right]$$

**Example 3.1.4** : A double heterojunction InGaAsP LED operating at 1310 nm has radiative and non-radiative recombination times of 30 and 100 ns respectively. The current injected is 40 Ma.

Calculate – Bulk recombination life time. Internal quantum efficiency Internal power level.

**Solution** :  $\lambda = 1310 \text{ nm} = (1.31 \times 10^{-6} \text{ m})$



$$\tau_r = 30 \text{ ns}$$

$$\tau_{nr} = 100 \text{ ns}$$

i)  $I = 40 \text{ MA} - 0.04 \text{ Amp.}$

**Bulk Recombination Life time ( $\tau$ ) :**

$$\eta_{int} = \frac{\tau}{\tau_r}$$

$$\frac{1}{\tau} = \frac{1}{\tau_r} + \frac{1}{\tau_{nr}}$$

**Internal quantum efficiency ( $\eta_{int}$ )**

$$\eta_{int} = \frac{23.07}{30}$$

$$\eta_{int} = 0.769$$

**Internal power level ( $P_{int}$ ) :**

$$P_{int} = \eta_{int} \cdot \frac{hc I}{q\lambda}$$

**Advantages and Disadvantages of LED**

**Advantages of LED**

- ii) Simple design.
- iii) Ease of manufacture.
- iv) Simple system integration.
- v) Low cost.

- vi) High reliability.

### **Disadvantages of LED**

1. Refraction of light at semiconductor/air interface.
2. The average life time of a radiative recombination is only a few nanoseconds, therefore
3. Modulation BW is limited to only few hundred megahertz.
4. Low coupling efficiency.
5. Large chromatic dispersion.

### **Comparison of Surface and Edge Emitting LED**

<b>LED type</b>	<b>Max. modulation freq. (MHz)</b>	<b>Output power (mW)</b>	<b>Fiber coupled power</b>
Surface emitting	60	< 4	< 0.2
Edge emitting	200	< 7	< 1.0

### **Injection Laser Diode (ILD)**

The laser is a device which amplifies the light, hence the LASER is an acronym for light amplification by stimulated emission of radiation.

The operation of the device may be described by the formation of an electromagnetic standing wave within a cavity (optical resonator) which provides an output of monochromatic highly coherent radiation.

## Principle :

Material absorb light than emitting. Three different fundamental process occurs between the two energy states of an atom. 1) Absorption 2) Spontaneous emission 3) Stimulated emission. Laser action is the result of three process absorption of energy packets (photons) spontaneous emission, and stimulated emission. (These processes are represented by the simple two-energy-level diagrams). Where  $E_1$  is the lower state energy level.  $E_2$  is the higher state energy level.

Quantum theory states that any atom exists only in certain discrete energy state, absorption or emission of light causes them to make a transition from one state to another. The frequency of the absorbed or emitted radiation  $f$  is related to the difference in energy  $E$  between the two states. If  $E_1$  is lower state energy level. and  $E_2$  is higher state energy level  $E = (E_2 - E_1) = h.f$ . Where,  $h = 6.626 \times 10^{-34}$  J/s (Plank's constant).

An atom is initially in the lower energy state, when the photon with energy  $(E_2 - E_1)$  is incident on the atom it will be excited into the higher energy state  $E_2$  through the absorption of the photon

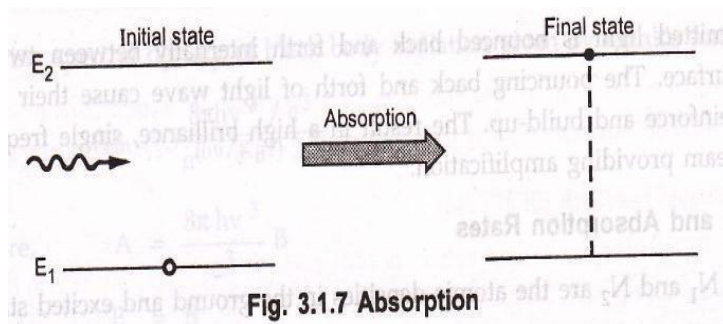
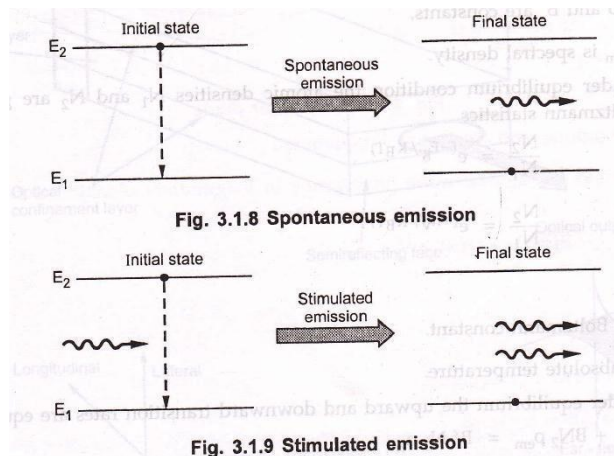

Fig. 3.1.7 Absorption

When the atom is initially in the higher energy state  $E_2$ , it can make a transition to the lower energy state  $E_1$  providing the emission of a photon at a frequency corresponding to  $h\nu = E_2 - E_1$ . The emission process can occur in two ways. By spontaneous emission in which the atom returns to the lower energy state in random manner.

By stimulated emission when a photon having equal energy to the difference between the two states ( $E_2 - E_1$ ) interacts with the atom causing it to the lower state with the creation of the second photon



Spontaneous emission gives incoherent radiation while stimulated emission gives coherent radiation. Hence the light associated with emitted photon is of same frequency of incident photon, and in same phase with same polarization.

It means that when an atom is stimulated to emit light energy by an incident wave, the liberated energy can add to the wave in constructive manner. The emitted light is bounced back and forth internally between two reflecting surface. The bouncing back and forth of light

wave cause their intensity to reinforce and build-up. The result in a high brilliance, single frequency light beam providing amplification.

### **Emission and Absorption Rates**

If  $N_1$  and  $N_2$  are the atomic densities in the ground and excited states.

#### **Rate of spontaneous emission**

$$R_{\text{spont}} = AN_2$$

#### **Rate of stimulated emission**

$$R_{\text{stim}} = BN_2 \rho_{\text{em}}$$

#### **Rate of absorption**

$$R_{\text{abs}} = B' N_1 \rho_{\text{em}}$$

where,

A, B and B' are constants.

$\rho_{\text{em}}$  is spectral density.

Under equilibrium condition the atomic densities  $N_1$  and  $N_2$  are given by Boltzmann statistics.

$$\frac{N_2}{N_1} = e^{(-E_B / K_B T)}$$

$$\frac{N_2}{N_1} = e^{(-h\nu / K_B T)}$$

where,

$K_B$  is Boltzmann constant.

T is absolute temperature.

Under equilibrium the upward and downward transition rates are equal.

$$AN_2 + BN_2 \rho_{\text{em}} = B' N_1 \rho_{\text{em}}$$

Spectral density  $p_{em}$

Comparing spectral density of black body radiation given by Plank's formula,

Therefore, ... A and B are called Einstein's coefficient.

## Fabry – Perot Resonator

Lasers are oscillators operating at frequency. The oscillator is formed by a resonant cavity providing a selective feedback. The cavity is normally a Fabry-Perot resonator i.e. two parallel plane mirrors separated by distance  $L$ ,

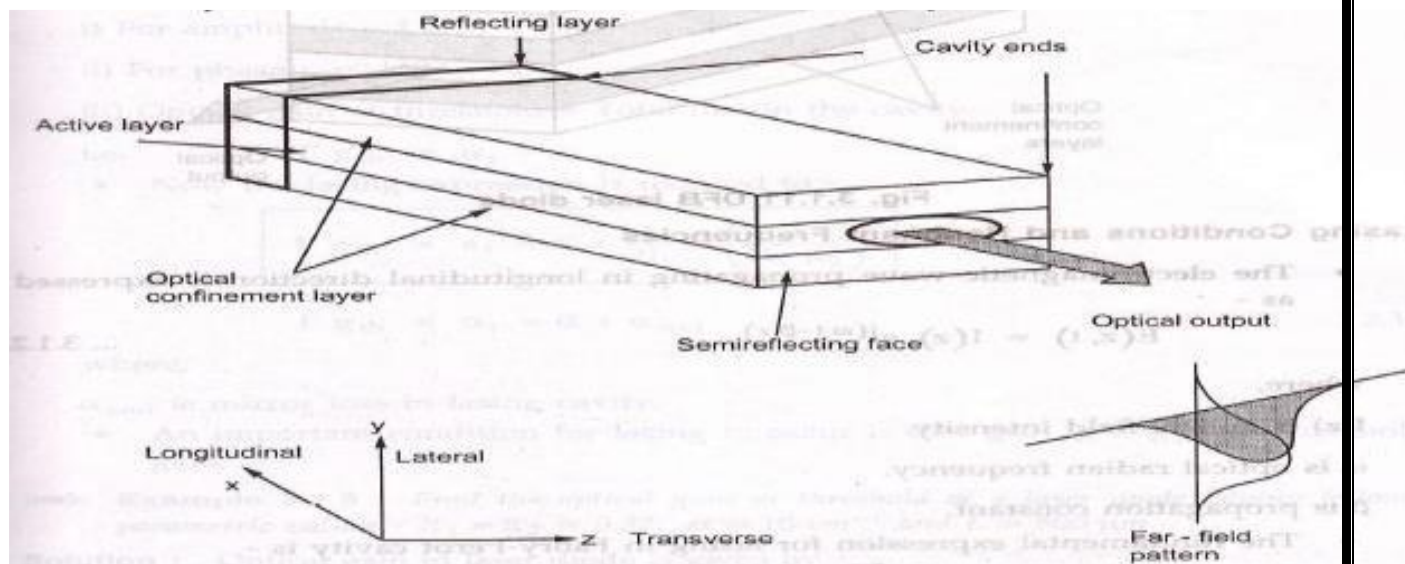

Light propagating along the axis of the interferometer is reflected by the mirrors back to the amplifying medium providing optical gain. The dimensions of cavity are 25-500  $\mu\text{m}$  longitudinal 5-15  $\mu\text{m}$  lateral and 0.1-0.2  $\mu\text{m}$  transverse. Fig. 3.1.10 shows Fabry-Perot resonator cavity for a laser diode.

The two heterojunctions provide carrier and optical confinement in a direction normal to the junction. The current at which lasing starts is the threshold current. Above this current the output power increases sharply.

### **Distributed Feedback (DFB) Laser**

In DFB laser the lasing action is obtained by periodic variations of refractive index along the longitudinal dimension of the diode. Fig. 3.1.11 shows the structure of DFB laser diode

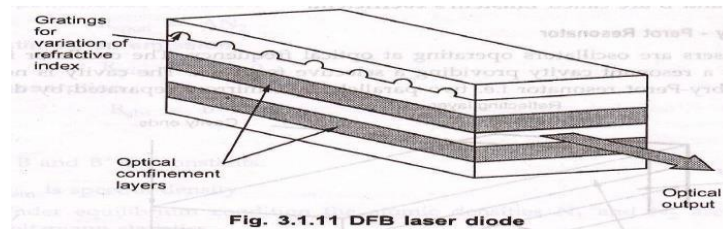

### **Lasing conditions and resonant Frequencies**

The electromagnetic wave propagating in longitudinal direction is expressed as –

$$E(z, t) = I(z) e^{j(\omega t - \beta z)}$$

where,

$I(z)$  is optical field intensity.

$\omega$  is optical radian frequency.

$\beta$  is propagation constant.

The fundamental expression for lasing in Fabry-Perot cavity is –

$$I(z) = I(0) e^{[\Gamma g(h\nu) - \alpha(h\nu)]z}$$

where,  $\Gamma$  is optical field confinement factor or the fraction of optical power in the active layer.

$\alpha$  is effective absorption coefficient of material.

$g$  is gain coefficient.

$h\nu$  is photon energy.

$z$  is distance traverses along the lasing cavity.

The condition of lasing threshold is given as –

For amplitude :  $I(2L) = I(0)$

For phase :  $e^{-j2\beta L} = 1$

Optical gain at threshold = Total loss in the cavity.

i.e.  $\Gamma g_{th} = \alpha_t$

Now the lasing expression is reduced to –

$$\Gamma g_{th} = \alpha_t = \alpha + \frac{1}{2L} \ln \left( \frac{1}{R_1 R_2} \right)$$

$$\Gamma g_{th} = \alpha_t = \alpha + \alpha_{end}$$

where,

$\alpha_{end}$  is mirror loss in lasing cavity. An important condition for lasing to occur is that gain,  $g \geq g_{th}$  i.e. threshold gain.

**Example 3.1.5** : Find the optical gain at threshold of a laser diode having following parametric values –  $R_1 = R_2 = 0.32$ ,  $\alpha = 10\text{cm}^{-1}$  and  $L = 500 \mu\text{m}$ .

**Solution** : Optical gain in laser diode is given by –

$$\Gamma g_{th} = 10 + \frac{1}{2 \times (500 \times 10^{-4})} \ln \left( \frac{1}{0.32 \times 0.32} \right)$$



$$\Gamma g_{th} = 33.7 \text{ cm}^{-1}$$

## Power Current Characteristics

The output optic power versus forward input current characteristics is plotted in Fig. 3.1.12 for a typical laser diode. Below the threshold current ( $I_{th}$ ) only spontaneous emission is emitted hence there is small increase in optic power with drive current. At threshold when lasing conditions are satisfied. The optical power increases sharply after the lasing threshold because of stimulated emission. The lasing threshold optical gain ( $g_{th}$ ) is related by threshold current density ( $J_{th}$ ) for stimulated emission by expression –

$$g_{th} = \beta$$

where,  $\beta$  is constant for device structure

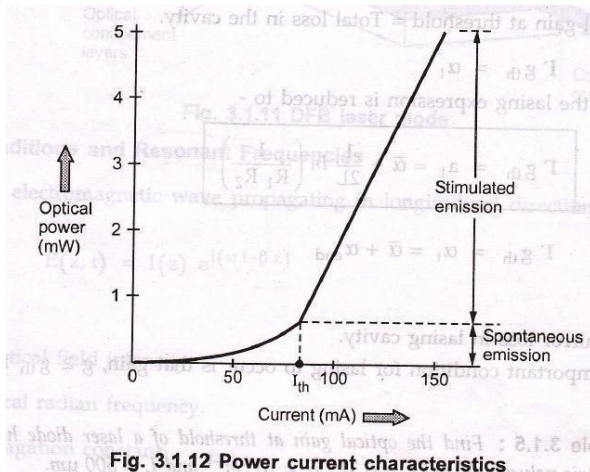

**Fig. 3.1.12 Power current characteristics**

## External Quantum Efficiency

The external quantum efficiency is defined as the number of photons emitted per electron hole pair recombination above threshold point. The external quantum efficiency  $\eta_{\text{ext}}$  is given by

$$\eta_{\text{ext}} = \frac{\eta_i (g_{\text{th}} - \alpha)}{g_{\text{th}}}$$

where,

$\eta_i$  = Internal quantum efficiency (0.6-0.7).

$g_{\text{th}}$  = Threshold gain.

$\alpha$  = Absorption coefficient

Typical value of  $\eta_{\text{ext}}$  for standard semiconductor laser is ranging between 15-20 %.

## Resonant Frequencies

At threshold lasing

$$2\beta L = 2\pi m$$

where, (propagation constant)

$m$  is an integer.

$$= 2L \cdot \frac{n}{\lambda}$$

Since

$$c = v\lambda$$

$$\lambda = \frac{c}{v}$$

Substituting  $\lambda$  in 3.1.30

$$m = 2L \frac{nv}{c}$$

Gain in any laser is a function of frequency. For a Gaussian output the gain and frequency are related by expression –

$$g(\lambda) = g(0)e^{-\frac{(\lambda-\lambda_0)^2}{2\sigma^2}}$$

where,  $g(0)$  is maximum gain.  $\lambda_0$  is center wavelength in spectrum.  $\sigma$  is spectral width of the gain. The frequency spacing between the two successive modes is –

$$\Delta \nu = \frac{c}{2Ln}$$

$$\Delta \lambda = \frac{\lambda^2}{2Ln}$$

### Optical Characteristics of LED and Laser

The output of laser diode depends on the drive current passing through it. At low drive current, the laser operates as an inefficient LED, When drive current crosses threshold value, lasing action begins. Fig. 3.1.13 illustrates graph comparing optical powers of LED operation (due to spontaneous emission) and laser operation (due to stimulated emission).

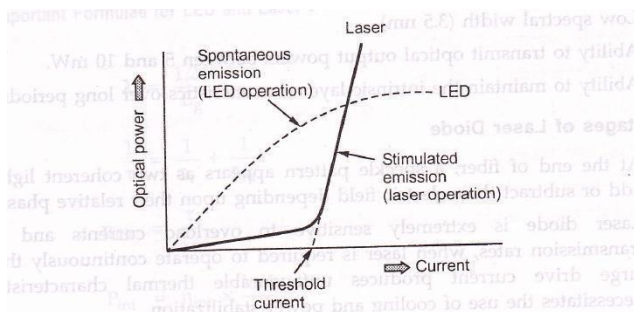
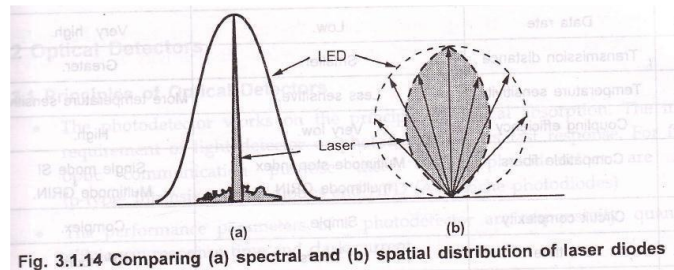

Fig. 3.1.13 Optical characteristics of an LED and laser compared

## Spectral and Spatial Distribution of Led and Laser

At low current laser diode acts like normal LED above threshold current, stimulated emission i.e. narrowing of light ray to a few spectral lines instead of broad spectral distribution, exist. This enables the laser to easily couple to single mode fiber and reduces the amount of uncoupled light (i.e. spatial radiation distribution). Fig. 3.1.14 shows spectral and spatial distribution difference between two diodes



## Advantages and Disadvantages of Laser Diode

### Advantages of Laser Diode

- Simple economic design.
- High optical power.
- Production of light can be precisely controlled.
- Can be used at high temperatures.

- Better modulation capability.
- High coupling efficiency.
- Low spectral width (3.5 nm)
- Ability to transmit optical output powers between 5 and 10 mW.
- Ability to maintain the intrinsic layer characteristics over long periods.

### **Disadvantages of Laser Diode**

- At the end of fiber, a speckle pattern appears as two coherent light beams add or subtract their electric field depending upon their relative phases.
- Laser diode is extremely sensitive to overload currents and at high transmission rates, when laser is required to operate continuously the use of large drive current produces unfavourable thermal characteristics and necessitates the use of cooling and power stabilization.

### **Comparison of LED and Laser Diode**

<b>S. No.</b>	<b>Parameter</b>	<b>LED</b>	<b>LD (Laser Diode)</b>
1	Principle of operation	Spontaneous emission.	Stimulated emission.
2	Output beam	Non – coherent	Coherent.
3	Spectral width	Broad spectrum (20 nm – 100 nm)	Much narrower (1-5 nm).
4	Data rate	Low.	Very high.
5	Transmission distance	Smaller.	Greater.
6	Temperature sensitivity	Less sensitive.	More temperature

			sensitive
7	Coupling efficiency	Very low.	High.
8	Compatible fibers	Multimode step index multimode GRIN	Single mode SI Multimode GRIN
9	Circuit complexity	Simple	Complex
10	Life time	105 hours.	104 hours.
11	Cost	Low.	High.
12	Output power	Linearly proportional to drive current	Proportional to current above the threshold
13	Current required	Drive current 50 to 100 mA peak.	Threshold current 5 to 40 ma
14	Applications	Moderate distance low data rate.	Long distance high data rates.

## Important Formulae for LED and Laser

### LED

- $\lambda = \frac{1.24}{E_g}$
- $\frac{1}{\tau} = \frac{1}{\tau_r} + \frac{1}{\tau_{nr}}$
- $\eta_{int} = \frac{\tau}{\tau_r}$

- $P_{\text{int}} = \eta_{\text{int}} \times \frac{hcI}{q\lambda}$

## LASER

1.  $\Gamma g_{\text{th}} = \alpha + \frac{1}{2L} \ln \left( \frac{1}{R_1 R_2} \right)$

2.  $\Delta \nu = \frac{c}{2Ln}$

3.  $\Delta \lambda = \frac{\lambda^2}{2Ln}$

## UNIT IV

### OPTICAL DETECTORS AND RECEIVERS

- The photo-diode is in fact a p-n junction put to the exact opposite use as the LED
- The variation in current is a function of the incident light
- Use of the stimulated absorption of light by the semiconductor material for the generation of electron-hole pairs.
- The energy of the absorbed photons to transfer the electrons from the ground to the excited state contributes to the variation in circuit current.
- The energy of the absorbed photon must at least be equal to the band-gap of the material for the material to respond to the incoming photons.

#### PIN diode

- A simple way to increase the depletion-region width is to insert a layer of undoped (or lightly doped) semiconductor material between the p-n junction.
- Since the middle layer consists of nearly intrinsic material, such a structure is referred to as the p-i-n photodiode.

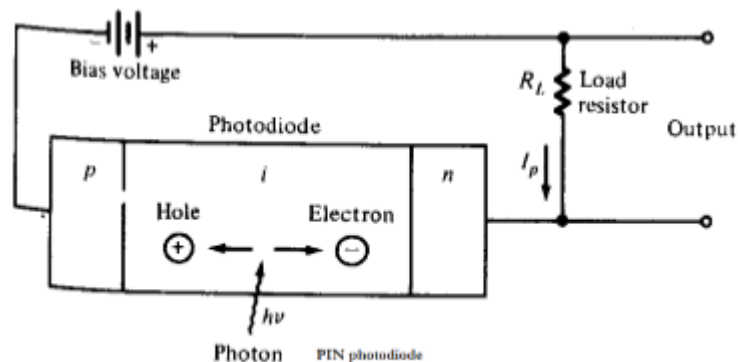

Figure 3.11



- When photon enters photodetector, the low band gap absorption layer absorbs the photon, and an electron-hole pair is generated. This electron hole pair is called photocarrier.
- These photocarriers, under the influence of a strong electric field generated by a reverse bias potential difference across the device as shown in figure produce photocurrent proportional to number of incident photons.

### Avalanche Photo Diode (APD)

- All detectors require a certain minimum current to operate reliably. The current requirement translates into a minimum power requirement through  $P_{in} = I_p R$ .
- Detectors with a large responsivity  $R$  are preferred since they require less optical power.
- The responsivity of p-i-n photodiodes is limited while Avalanche photodiode (APDs) can have much larger values of  $R$ .

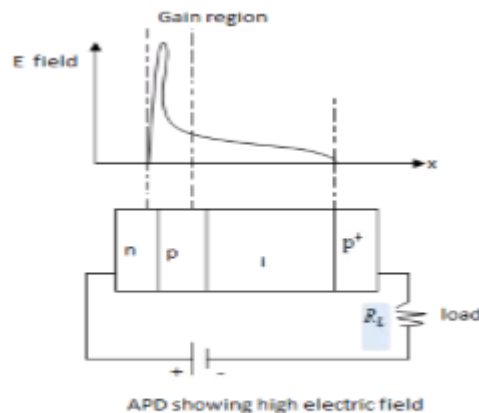

Figure 3.12: APD

## Working of APD

- APD is similar to PIN diode the exception is the addition of high intensity electric field region.
- In this region primary electron hole pairs are generated by the incident photons which are able to absorb enough kinetic energy from strong electric field to collide with the atoms present in this region, thus generating more electron hole pairs.
- The physical phenomenon behind the internal current gain is known as the impact ionization.
- This impact ionization leads to avalanche breakdown in ordinary reverse bias. It requires very high reverse bias voltage in order that the new carriers created by impact ionization can themselves produce additional carriers by same mechanism.
- This process of generating more than one electron hole pair from incident photon through ionization process is referred to as the avalanche effect.
- Thus the avalanche multiplication results in amplification of photodiode current.
- Multiplication factor: Multiplication factor  $M$  is a measure of internal gain provided by APD. It is defined as the ratio of total multiplied output current to the primary un multiplied current.

$$M = I / I_p$$

Where  $I$  the Total multiplied output current

$I_p$  is the primary un multiplied current

Multiplication depends on physical and operational characteristics of photo detector device. Operational characteristics include the width of avalanche region, the strength of electric field and type of semiconductor material employed.

### Comparison:

Sr no.	PIN diode	APD (Avalanche photodiode)
1	PIN does not have high intensity electric field region.	APD has high intensity electric field region.
2	Photo current ( $I_p$ ) generated is less compared to APD $I_p = qN\theta$ , q = electron charge, N $\theta$ = carrier number	Photo current ( $I_p$ ) generated is more compared to PIN, $I_p = qN\theta.M$ q = electron charge, N $\theta$ = carrier number, M = multiplication factor
3	Responsivity of PIN is limited.	Responsivity of APD can have much larger values.
4	They exhibit lower noise levels.	They exhibit higher noise levels as compared to PIN due to impact ionization and photocurrent multiplication.
5	Response time of PIN is half that of APD.	Response time of APD is almost double that of PIN.

The PIN-diode is an alteration of the PN-junction for particular applications. After the PN-junction diode was developed in the year 1940s, the diode was first exercised as a high-power rectifier, low-frequency during the year 1952. The occurrence of an intrinsic layer can significantly increase the breakdown voltage for the application of high-voltage. This intrinsic layer also offers exciting properties when the device operates at high frequencies in the range of radio wave and microwave. A PIN diode is a one kind of diode with an undoped, wide intrinsic semiconductor region between a P-type and N-type semiconductor region. These regions are normally heavily doped as they are used for Ohmic contacts. The wider intrinsic region is indifference to an ordinary p–n diode. This region makes the diode an inferior rectifier but it makes it appropriate for fast switches, attenuators, photo detectors and high voltage power electronics applications.

The PIN diode is a one type of photo detector, used to convert optical signal into an electrical signal. The PIN diode comprises of three regions, namely P-region, I-region and N-region. Typically, both the P and N regions are heavily doped due to they are utilized for Ohmic contacts. The intrinsic region in the diode is in contrast to a PN junction diode. This region makes the PIN diode a lower rectifier, but it makes it appropriate for fast switches, attenuators, photo detectors and applications of high voltage power electronics.

### **Photo detectors:**

These are Opto-electric devices i.e. to convert the optical signal back into electrical impulses. The light detectors are commonly made up of semiconductor material. Photo detectors made up of semiconductor material. When the light strikes the light detector a current is produced in the external circuit proportional to the intensity of the incident light.

Optical signal generally is weakened and distorted when it emerges from the end of the fiber, the photo detector must meet following strict performance requirements.

- A high sensitivity to the emission wavelength range of the received light signal
- A minimum addition of noise to the signal
- A fast response speed to handle the desired data rate
- Be insensitive to temperature variations
- Be compatible with the physical dimensions of the fiber
- Have a Reasonable cost compared to other system components
- Have a long operating lifetime

Some important parameters while discussing photo detectors:

### **Quantum Efficiency**

It is the ratio of primary electron-hole pairs created by incident photon to the photon incident on the diode material.

### **Detector Responsivity**

This is the ratio of output current to input optical power. Hence this is the efficiency of the device.

### **Spectral Response Range**

This is the range of wavelengths over which the device will operate.

### **Noise Characteristics**

The level of noise produced in the device is critical to its operation at low levels of input light.

### **Response Time**

This is a measure of how quickly the detector can respond to variations in the input light intensity.

### **Types of Light Detectors**

- PIN Photodiode

➤ Avalanche Photodiode

PIN photodiode



InGaAs avalanche photodiode



**Photo detector materials**

Operating Wavelength Ranges for Several Different Photo detector Materials

Material	Energy gap, eV	$\lambda_{\text{cutoff}}$ , nm	Wavelength range, nm
Silicon	1.17	1060	400–1060
Germanium	0.775	1600	600–1600
GaAs	1.424	870	650–870
InGaAs	0.73	1700	900–1700
InGaAsP	0.75–1.35	1650–920	800–1650

In GaAs is used most commonly for both long-wavelength pin and avalanche photodiodes

## Physical Principles of Photodiodes

### The Pin Photodetector

- The device structure consists of p and n semiconductor regions separated by a very lightly n-doped intrinsic (i) region.
- In normal operation a reverse-bias voltage is applied across the device so that no free electrons or holes exist in the intrinsic region.
- Incident photon having energy greater than or equal to the band gap energy of the semiconductor material, give up its energy and excite an electron from the valence band to the conduction band

### Pin Photodetector

the high electric field present in the depletion region causes photogenerated carriers to separate and be collected across the reverse – biased junction. This gives rise to a current flow in an external circuit, known as photocurrent.

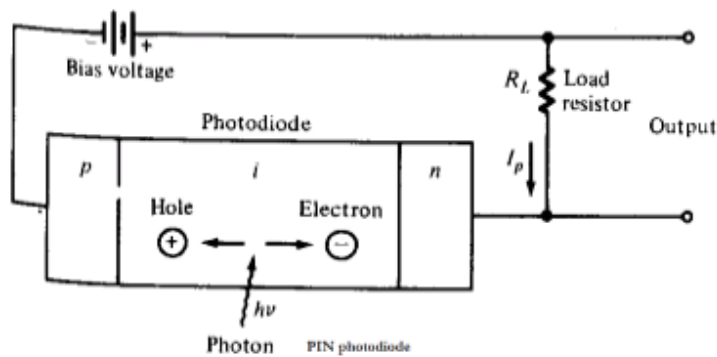

Figure 3.11

### Photo carriers:

Incident photon, generates free (mobile) electron-hole pairs in the intrinsic region. These charge carriers are known as photocarriers, since they are generated by a photon.

### Photocurrent:

The electric field across the device causes the photocarriers to be swept out of the intrinsic region, thereby giving rise to a current flow in an external circuit. This current flow is known as the photocurrent.

### Energy-Band diagram for a pin photodiode

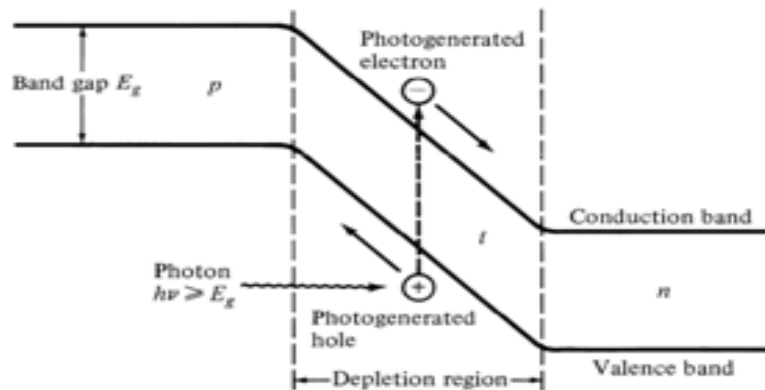

An incident photon is able to boost an electron to the conduction band only if it has an energy that is greater than or equal to the bandgap energy

Beyond a certain wavelength, the light will not be absorbed by the material since the wavelength of a photon is inversely proportional to its energy

Thus, a particular semiconductor material can be used only over a limited wavelength range.



The upper wavelength  $\lambda_c$  cutoff is determined by the band-gap energy  $E_g$  of the material.

$$\lambda_c = \frac{hc}{E_g}$$

- As the charge carriers flow through the material some of them recombine and disappear.
- The charge carriers move a distance  $L_n$  or  $L_p$  for electrons and holes before recombining. This distance is known as diffusion length
- The time it take to recombine is its life time  $\tau_n$  or  $\tau_p$  respectively.

$$L_n = (D_n \tau_n)^{1/2} \text{ and } L_p = (D_p \tau_p)^{1/2}$$

- Where  $D_n$  and  $D_p$  are the diffusion coefficients for electrons and holes respectively.

### Photocurrent

- As a photon flux penetrates through the semiconductor, it will be absorbed.
- If  $P_{in}$  is the optical power falling on the photo detector at  $x=0$  and  $P(x)$  is the power level at a distance  $x$  into the material then the incremental change be given as

$$dP(x) = -\alpha_s(\lambda)P(x)dx$$

Where  $\alpha_s(\lambda)$  is the photon absorption coefficient at a wavelength  $\lambda$ .

So that

$$P(x) = P_{in} \exp(-\alpha_s x)$$

- Optical power absorbed,  $P(x)$ , in the depletion region can be written in terms of incident optical power,  $P_{in}$  :

$$P(x) = P_{in} (1 - e^{-\alpha_s(\lambda)x})$$

- Absorption coefficient  $\alpha_s(\lambda)$  strongly depends on wavelength. The upper wavelength cut-off for any semiconductor can be determined by its energy gap as follows:

$$\lambda_c (\mu\text{m}) = \frac{1.24}{E_g (\text{eV})}$$

- Taking entrance face reflectivity into consideration, the absorbed power in the width of depletion region,  $w$ , becomes:

$$(1 - R_f)P(w) = P_{in}(1 - e^{-\alpha_s(\lambda)w})(1 - R_f)$$

### **Detector Response Time**

The response time of photodiode together with its output circuit depends mainly on the following three factors:

1. The transit time of the photocarriers in the depletion region.
2. The diffusion time of the photocarriers generated outside the depletion region.
3. The RC time constant of the photodiode and its associated circuit.

S.No	Parameters	PIN	APD
1	Sensitivity	Less sensitive (0-12 dB)	More sensitive (5-15 dB)
2	Biasing	Low reverse biased voltage (5 to 10 V)	High reverse biased voltage (20-400 volts)
3	Wavelength region	300- 1100 nm	400 -1000 nm
4	Gain	No Internal gain	Internal gain

## Optical Receiver Design

The receiver must first detect weak, distorted signal and then make decisions on what type of data was sent based on amplified version of the distorted signal. To understand the function of the receiver, we first examine what happens to the signal as it is sent through the optical data link which is shown in the following figure

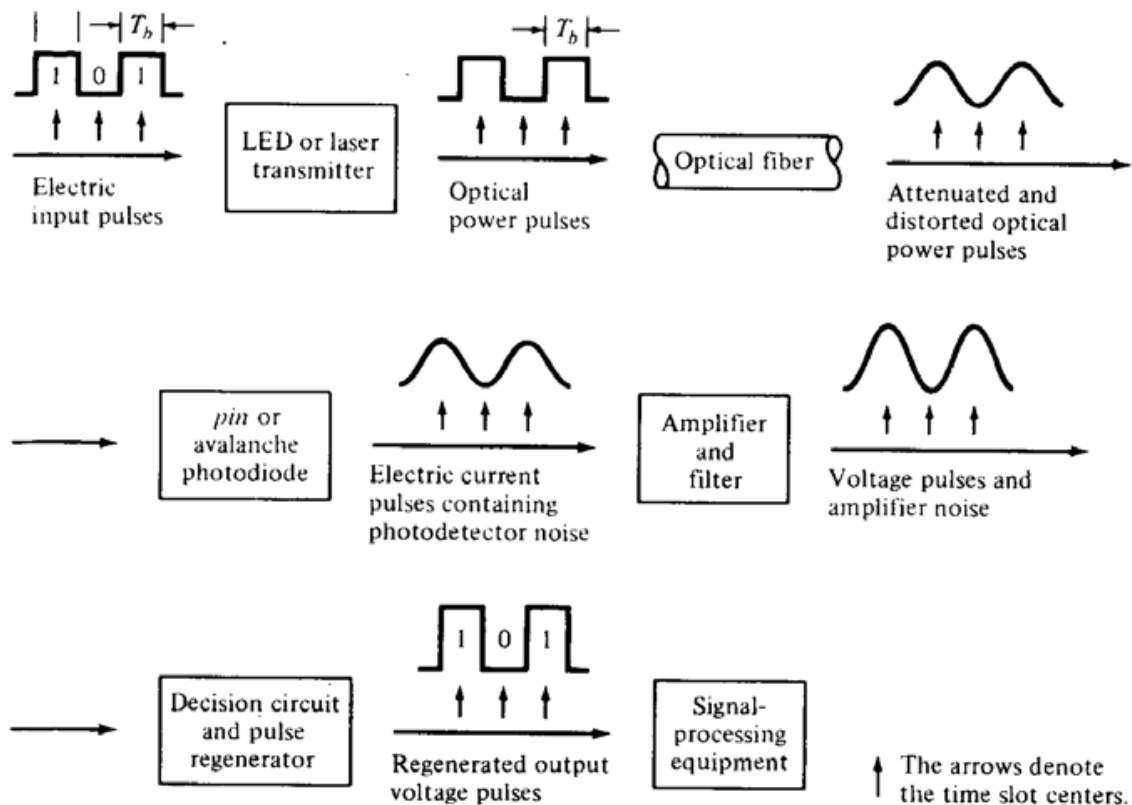

A digital fiber transmission link is shown in the above figure. The transmitted signal is a two level binary data stream consisting of either a 0 or 1 in a time slot of duration  $T_b$ . This time slot is referred to as bit period. Electrically there are many ways of sending a given digital message. One of the simplest techniques for sending binary data is **Amplitude Shift Keying (ASK)**, wherein a voltage level is switched between two values, which are generally on and off. The resultant signal wave thus consists of a voltage pulse of amplitude  $V$  relative to zero voltage level when a binary 1 occurs and a zero voltage level space when a binary 0 occurs. When a 1 is sent, a voltage pulse of duration  $T_b$  occurs, whereas for a 0 the voltage remains at its zero level.

The function of the optical transmitter is to convert the electric signal to an optic signal. Here 1 is represented by a pulse of optical power (light) of duration  $T_b$ , whereas a 0 is the absence of any light. The optical signal that gets coupled from the light source to the fiber becomes attenuated and distorted as it propagates along the fiber waveguide. Upon reaching the receiver either a pin or an avalanche photodiode converts the optical signal back to an electric format. The electric signal then gets amplified and filtered. A decision circuit compares

The signal in each time slot with a certain reference voltage known as the threshold level. If the received signal level is greater than the threshold level, a 0 is assumed to be received. In some cases an optical amplifier is placed ahead of the photodiode to boost the optical signal level before photodetection. This is done so that the signal to noise ratio degradation caused by thermal noise in the receiver electronics can be suppressed. Compared to APD's or optical heterodyne detectors, an optical preamplifier provides a large gain factor and a broader bandwidth.

### Error Sources:

Errors arise from various noise and disturbances associated with the signal detection system which is shown in the following figure.

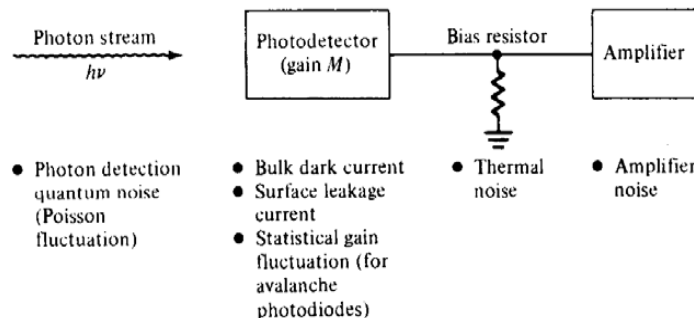

**Fig: Noise sources and disturbances in the optical pulse detection mechanism.**

An optical receiver system converts optical energy into electrical signal, amplify the signal and process it. Therefore the important blocks of optical receiver are

- Photo detector / Front-end
- Amplifier / Linear channel
- Signal processing circuitry / Data recovery.

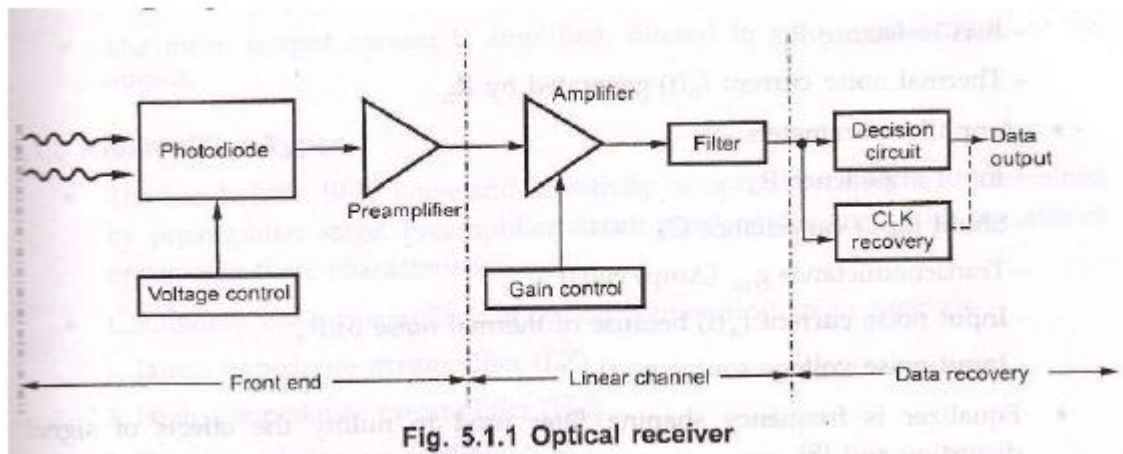

Noise generated in receiver must be controlled precisely as it decides the lowest signal level that can be detected and processed. Hence noise consideration is an important factor in receiver design. Another important performance criteria of optical receiver is average error probability.

**Receiver Configuration**

Configuration of typical optical receiver is shown in Fig

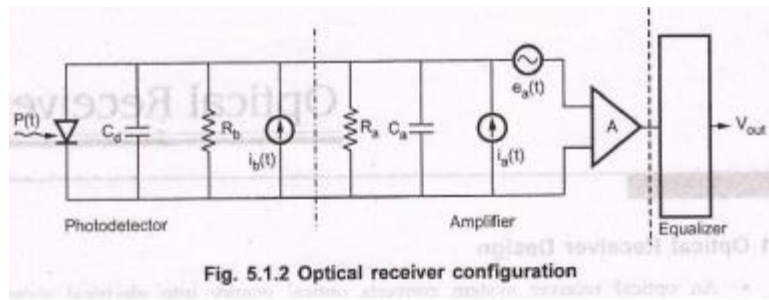

## UNIT-V

### OPTICAL SYSTEM DESIGN

#### SYSTEM DESIGN FACTORS

To achieve high-quality transmission, careful decisions based on operating parameters apply for each component of a fiber optic transmission system. The main questions, given in Table 10.1, involve data rates and bit error rates in digital systems, bandwidth, linearity, and signal-to-noise ratios in analog systems, and in all systems, transmission distances. These questions of how far, how good, and how fast define the basic application constraints. Once these are decided, it is time to evaluate the other factors involved.

Table: Factors for Evaluating Fiber Optic System Design

System Factor	Consideration/Choices
Type of Fiber	Single-mode or Multimode
Dispersion	Regenerators or Dispersion Compensation
Fiber Nonlinearities	Fiber Characteristics, Wavelengths, and Transmitter Power
Operating Wavelength	780, 850, 1310, 1550 nm, and 1625 nm typical.
Transmitter Power	Typically expressed in dBm.
Source Type	LED or Laser
Receiver Sensitivity/Overload Characteristics	Typically expressed in dBm.
Detector Type	PIN Diode, APD, or IDP



System Factor	Consideration/Choices
Modulation Code	AM, FM, PCM, or Digital
Bit Error Rate (BER) (Digital Systems Only)	$10^{-9}$ , $10^{-12}$ Typical
Signal-to-Noise Ratio	Specified in decibels (dB).
Number of Connectors	Loss increases with the number of connectors.
Number of Splices	Loss increases with the number of splices.
Environmental Requirements	Humidity, Temperature, Exposure to Sunlight
Mechanical Requirements	Flammability, Indoor/Outdoor Application

Many of these considerations are directly related to other considerations. For example, detector choice will impact the receiver sensitivity which will affect the necessary transmitter output power. Output power impacts the transmitter light emitter type which will affect the usable fiber type and connector type. A logical way to proceed with designing a fiber link involves analyzing the fiber optic link power budget or optical link loss budget.

#### **SYSTEM DESIGN CONSIDERATIONS:**

In optical system design major consideration involves

1. Transmission characteristics of fiber (attenuation & dispersion).
2. Information transfer capability of fiber.
3. Terminal equipment & technology.
4. Distance of transmission.

An optical communication system should have following basic required specifications

- Transmission type (Analog / digital).
- System fidelity (SNR / BER)
- Required transmission bandwidth

- Acceptable repeater spacing
- Cost of system
- Reliability
- Cost of maintenance.

### **SYSTEM CONSIDERATION:**

Before selecting suitable components, the operating wavelength for the system is decided. The operating wavelength selection depends on the distance and attenuation. For shorter distance, the 800-900 nm region is preferred but for longer distance 100 or 1550 nm region is preferred due to lower attenuations and dispersion.

The next step is selection of photo detector. While selecting a photo detector following factors are considered –

- Minimum optical power that must fall on photo detector to satisfy BER at specified data rate.
- Complexity of circuit.
- Cost of design.
- Bias requirements.

Next step in system consideration is choosing a proper optical source;

Important factors to consider are –

- Signal dispersion.
- Data rate.
- Transmission distance.
- Cost.
- Optical power coupling.
- Circuit complexity.

The last factor in system consideration is to selection of optical fiber between single mode and Multimode fiber with step or graded index fiber. Fiber selection depends on type of optical source and tolerable dispersion.

Some important factors for selection of fiber are:

- Numerical Aperture (NA), as NA increases, the fiber coupled power increases also the Dispersion.
- Attenuation characteristics.
- Environmental induced losses e.g. due to temperature variation, moisture and dust etc.

#### **Operating wavelength selection:**

- First generation optical wavelength are in the range of  $0.8\mu\text{m}$  to  $0.9\mu\text{m}$ . Here the transmission loss is maximum and dispersion is also maximum.
- Today we choose the wavelength around  $1.3\mu\text{m}$  to  $1.55\mu\text{m}$ . Here the attenuation and dispersion are very small in silica fibers are used for long distance transmission.

#### **System performance:**

- System performance is decided by three major blocks (or) the optical fiber transmission. They are transmitter, optical fiber links and receiver. The designer should choose proper light source, proper optical fiber and proper photo detector to get high bit rate and high S/N ratio.
- Regarding optical fiber, the single mode step index fiber is the proper choice. Even in that to reduce dispersion proper choice of the refractive index profile is necessary. These single mode step index fibers are preferable.
- Regarding optical sources, single mode laser diodes are suitable for single mode step index fibers. For multi mode fibers, hetero junction LEDs chosen based economy.

- Regarding optical receivers, the P-i-n photodiodes and avalanche photodiodes are preferable. Here also they should be quantum noise limited.

The maximum transmission distance is limited by the net loss of fiber cable such that

$$L = 10 / \alpha \log_{10} (P_t / P_r)$$

$\alpha$  = net loss (in dB/1cm)

$P_t$  = average power from transmitter

$P_r$  = average power detected at receiver =  $N_p h \nu B$

$N_p$  = minimum no of photons/bit required

$h \nu$  = energy of photon

$B$  = bit rate

## COMPONENT CHOICE:

Fiber optic communications systems include components unfamiliar to most communications system designers, but their design is based on principles that differ little from their conventional counterparts. Link analysis is carried out in much the same way as for an electrical cable system. The chief distinction results from the increased bandwidth capability with fiber optic systems, which allows the design engineer to make different trade-offs in determining the optimum transmission format as well as source, detector, and cable types.

The system designer has many choices when selecting components for an optical fiber system. The major components choices are,

### Optical Fiber Type and Parameters

Multimode or single mode, size, refractive index, attenuation, dispersion, mode coupling, strength, joints etc.

### Source Type

Laser or LED, optical power launched into the fiber, rise and fall time, stability etc.,

### **Transmitter Configuration**

Design for digital or analog, input impedance, supply voltage, dynamic range, feedback etc.

### **Detector Type and Characteristics**

PN, PIN or Avalanche photodiode, response time, active diameter, bias voltage, dark current etc.

### **Receiver Configuration**

Preamplifier design, BER, SNR, range etc.

### **Modulation and Coding**

Source intensity modulation, pulse frequency modulation, PWM and PPM transmission.

### **Digital transmission or analog transmission**

Such as biphasic scheme and FM respectively. These decisions will be taken depending on the system performance, ready availability of suitable components and cost.

The short comings of the components can be mentioned as follows,

- LED may appear ideally suitable for analog transmission most of the LED display some degree of non-linearity in their output.
- The thermal behavior of LED and Lasers can limit their operation. Significant increase in junction temperature may cause loss of lasing and reduction in optical output power. Finite spectral width can cause pulse broadening due to material dispersion on an optical fiber communication link.

### **System Design Considerations**

- In optical system design major consideration involves
  - Transmission characteristics of fiber (attenuation & dispersion).
  - Information transfer capability of fiber.
  - Terminal equipment & technology.

- Distance of transmission.
- In long-haul communication applications repeaters are inserted at regular intervals as shown in Fig. 6.2.1

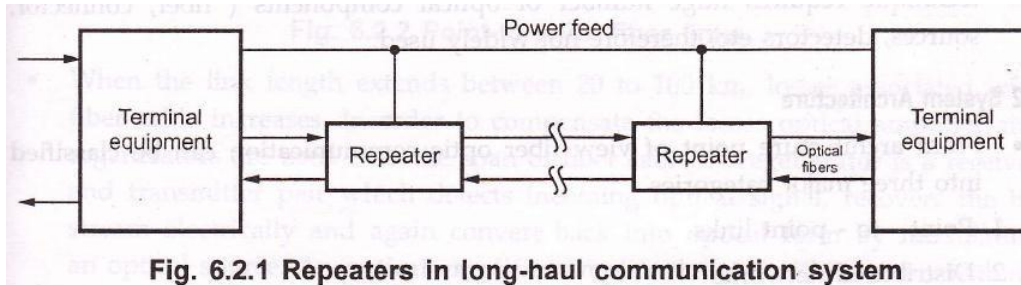

**Fig. 6.2.1 Repeaters in long-haul communication system**

- Repeater regenerates the original data before it is retransmitted as a digital optical signal. The cost of system and complexity increases because of installation of repeaters.
- An optical communication system should have following basic required specifications –
  - a) Transmission type (Analog / digital).
  - b) System fidelity (SNR / BER)
  - c) Required transmission bandwidth
  - d) Acceptable repeater spacing
  - e) Cost of system
  - f) Reliability
  - g) Cost of maintenance.

## **Multiplexing**

- Multiplexing of several signals on a single fiber increases information transfer rate of communication link. In Time Division Multiplexing (TDM) pulses from multiple channels are interleaved and transmitted sequentially, it enhance the bandwidth utilization of a single fiber link.
- In Frequency Division Multiplexing (FDM) the optical channel bandwidth is divided into various no overlapping frequency bands and each signal is assigned one of these bands of frequencies. By suitable filtering the combined FDM signal can be retrieved.
- When number of optical sources operating at different wavelengths is to be sent on single fiber link Wavelength Division Multiplexing (WDM) is used. At receiver end, the separation or extraction of optical signal is performed by optical filters (interference filters, diffraction filters prism filters).
- Another technique called Space Division Multiplexing (SDM) used separate fiber within fiber bundle for each signal channel. SDM provides better optical isolation which eliminates cross-coupling between channels. But this technique requires huge number of optical components (fiber, connector, sources, detectors etc) therefore not widely used.

## **System Architecture**

From architecture point of view fiber optic communication can be classified into three major categories.

- Point – to – point links
- Distributed networks
- Local area networks.

### Point-to-Point Links

A point-to-point link comprises of one transmitter and a receiver system. This is the simplest form of optical communication link and it sets the basis for examining complex optical communication links. For analyzing the performance of any link following important aspects are to be considered.

- Distance of transmission
- Channel data rate
- Bit-error rate

All above parameters of transmission link are associated with the characteristics of various devices employed in the link. Important components and their characteristics are listed below.

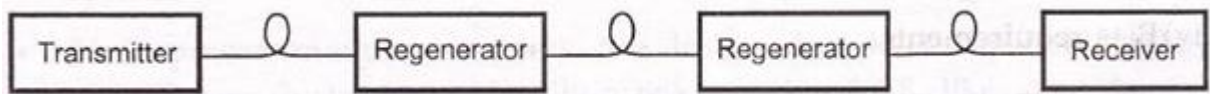

When the link length extends between 20 to 100 km, losses associated with fiber cable increases. In order to compensate the losses optical amplifier and regenerators are used over the span of fiber cable. A regenerator is a receiver and transmitter pair which detects incoming optical signal, recovers the bit stream electrically and again convert back into optical form by modulating an optical source. An optical amplifier amplifies the optical bit stream without converting it into electrical form.

The spacing between two repeater or optical amplifier is called as repeater spacing (L). The repeater spacing L depends on bit rate B. The bit rate-distance product (BL) is a measure of system performance for point-to-point links.

- Two important analysis for deciding performance of any fiber link are –
  - i) Link power budget / Power budget
  - ii) Rise time budget / Bandwidth budget



Point to point fiber optic lines is the simplest transmission line. This type of link places the least demand on optical fiber technology and thus sets the basis for examine more complex system architecture.

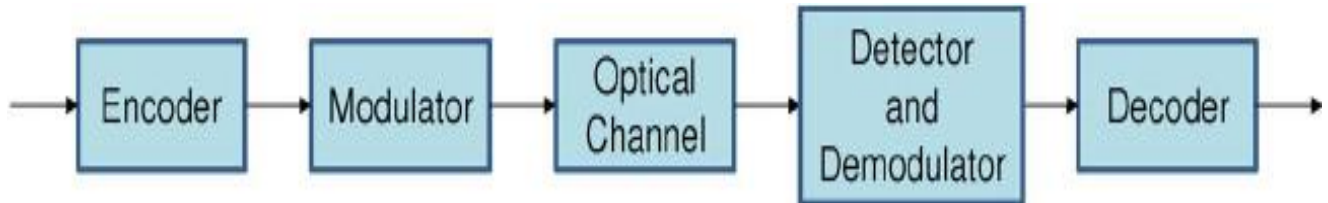

Fig: Simple point to point link

The repeaters may be on to electronic (or) optical repeaters. In this system, the repeater spacing is a major design factor spacing between repeater increases, it reduces the system cost spacing between transmitters receiver increases, it will also increases system cost.(ie transmission distance **and** increases)

If L increases then bit rate reduces because of dispersion thus, product of B(bit rate) and transmission distance(L) is a measure of system performance and its depends on operating wavelength

Operating wavelength		BL product
0.854m		1Gb/s-Kn
1.34μm	—————→	1 Tb/s-Km
1.55μm	—————→	100Tb/s-km

To analyze the point to point link,One should know the system requirements such as the maximum transmission distance, required data rate and allowed bit error rate (BER).

To satisfy these requirements the system should be designed based on the components available and their characteristics.

1. Multimode (or) single mode fiber (transmission media)

- (a) Core radius
- (b) Fiber refractive index profile
- (c) Bandwidth (or) dispersion
- (d) Fiber attenuation
- (e) Numerical aperture

2. Optical sources (LED or laser diode)

- (a) Emission wavelength
- (b) Output power
- (c) Spectral line width
- (d) Radiation pattern
- (e) Radiating area
- (f) no. of emitted modes
- (g) Stability and life time.

3. Light detectors (PIN (or) APD)

- (a) Responsivity
- (b) Efficiency wavelength
- (c) Operating
- (d) Speed
- (e) Sensitivity
- (f) Noise figure

## LINK POWER BUDGET:

For optimizing link power budget an optical power loss model is to be studied as shown in Fig.

Let

- $l_c$  denotes the losses occur at connector.
- $L_{sp}$  denotes the losses occur at splices.
- $\alpha_f$  denotes the losses occur in fiber.

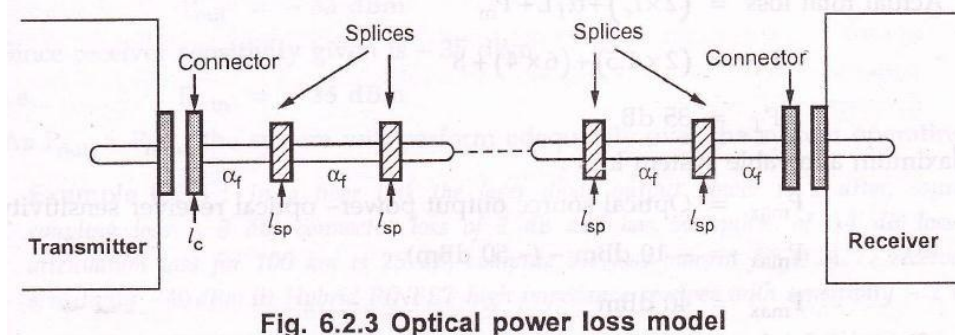

Fig. 6.2.3 Optical power loss model

- All the losses from source to detector comprises the total loss (PT) in the system.
- Link power margin considers the losses due to component aging and temperature fluctuations. Usually a link margin of 6-8 dB is considered while estimating link power budget.

Total optical loss = Connector loss + (Splicing loss + Fiber attenuation) + System margin ( $P_m$ )

$$PT = 2l_c + \alpha_f L + \text{System margin } (P_m)$$

Where,

$L$  is transmission distance.

**Example:** Design an optical fiber link for transmitting 15 Mb/sec of data for a distance of 4 km with BER of  $10^{-9}$ .

**Solution:**

Bandwidth x Length = 15 Mb/sec x 4 km = (60 Mb/sec) km

**Selecting optical source:** LED at 820 nm is suitable for short distances. The LED generates – 10 dBm optical powers.

**Selecting optical detector:** PIN-FER optical detector is reliable and has – 50 dBm sensitivity.

**Selection optical fiber:** Step-index multimode fiber is selected. The fiber has bandwidth length product of 100 (Mb/s) km.

**Links power budget:**

Assuming:

Splicing loss  $l_s = 0.5$  dB/slice

Connector loss  $l_c = 1.5$  dB

System link power margin  $P_m = 8$  dB

Fiber attenuation  $\alpha f = 6$  dB/km

Actual total loss =  $(2 \times l_c) + \alpha f L + P_m$

$PT = (2 \times 1.5) + (6 \times 4) + 8$

$PT = 35$  dB

Maximum allowable system loss :

$P_{max} =$  Optical source output power- optical receiver sensitivity  $P_{max} = -10$  dBm – (-50 dBm)

$P_{max} = 40$  dBm

Since actual losses in the system are less than the allowable loss, hence the system is functional.

**Example:** A transmitter has an output power of 0.1 mW. It is used with a fiber having NA= 0.25, attenuation of 6 dB/km and length 0.5 km. The link contains two connectors of 2 dB average loss. The receiver has a minimum acceptable power (sensitivity) of – 35 dBm. The designer has allowed a 4 dB margin. Calculate the link power budget.

**Solution:**

Source power  $P_s = 0.1\text{mW}$

$P_s = -10\text{dBm}$

Since  $NA = 0.25$

Coupling loss =  $-10\log(NA^2)$

=  $-10\log(0.25^2)$

= 12 dB

Fiber loss =  $\alpha_f \times L$

$l_f = (6\text{dB/km})(0.5\text{km})$   $l_f = 3\text{ dB}$

Connector loss = 2 (2 dB)

$l_c = 4\text{ dB}$  Design margin  $P_m = 4\text{ dB}$

Actual output power  $P_{out} = \text{Source power} - (\sum \text{Losses})$   $P_{out} = 10\text{dBm} - [12\text{ dB} + 3 + 4 + 4]$

$P_{out} = -33\text{ dBm}$

Since receiver sensitivity given is – 35 dBm.

$P_{min} = -35\text{ dBm}$

As  $P_{out} > P_{min}$ , the system will perform adequately over the system operating life.

**Example:** In a fiber link the laser diode output power is 5 dBm, source-fiber coupling loss= 3 dB, connector loss of 2 dB and has 50 splices of 0.1 dB loss. Fiber attenuation loss for 100 km is 25 dB, compute the loss margin for i) APD receiver with sensitivity – 40 dBm ii) Hybrid PINFET high impedance receiver with sensitivity -32 dBm.

**Solution:** Power budget calculations

Source output power	<b>5 dBm</b>
Source fiber coupling loss	<b>3 dB</b>
Connector loss	<b>2 dB</b>
Connector loss	<b>5 dB</b>
Fiber attenuation	<b>25 dB</b>
Total loss	<b>35 dB</b>

Available power to receiver :  $(5 \text{ dBm} - 35 \text{ dBm}) - 30 \text{ dBm}$

APD receiver sensitivity – 40 dBm

Loss margin  $[- 40 - (- 30)]$  10dBm

H-PIN FET high impedance receiver -32 dBm Loss margin  $[- 32 - (- 30)]$  2 dBm

## Rise Time Budget

Rise time gives important information for initial system design. Rise-time budget analysis determines the dispersion limitation of an optical fiber link.

Total rise time of a fiber link is the root-sum-square of rise time of each contributor to the pulse rise time degradation.

$$t_{sys} = \sqrt{t_{r1}^2 + t_{r2}^2 + t_{r3}^2 + \dots}$$

$$t_{sys} = \left( \sum_{i=1}^N t_{ri}^2 \right)^{1/2}$$

The link components must be switched fast enough and the fiber dispersion must be low enough to meet the bandwidth requirements of the application. Adequate bandwidth for a system can be assured by developing a rise time budget.

As the light sources and detectors have a finite response time to inputs, the device does not turn-on or turn-off instantaneously. Rise time and fall time determine the overall response time and hence the resulting bandwidth.

Connectors, couplers and splices do not affect system speed, they need not be accounted in rise time budget but they appear in the link power budget. Four basic elements that contribute to the rise-time are,

Transmitter rise-time (ttx)

Group Velocity Dispersion (GVD) rise time (tGVD) Modal dispersion rise time of fiber (tmod)

Receiver rise time (trx)

Where,

$B_{rx}$  is 3 dB – bW of receiver (MHz).

Rise time due to modal dispersion is given as

$$t_{\text{mod}} = \frac{440}{B_M} = \frac{440 Lq}{B_0}$$

where,

$B_M$  is bandwidth (MHz)

L is length of fiber (km)

q is a parameter ranging between 0.5 and 1.

$B_0$  is bandwidth of 1 km length fiber

- Rise time due to group velocity dispersion is

$$t_{\text{GVD}} = D^2 \sigma_\lambda^2 L^2$$

Where,

D is dispersion [ns/(nm.km)]

$\Sigma_\lambda$  is half-power spectral width of source L is length of fiber

- Receiver front end rise-time in nanoseconds is

$$t_{\text{rx}} = \frac{350}{B_{\text{rx}}}$$



Equation (6.2.1) can be written as

$$t_{sys} = [t_{tx}^2 + t_{mod}^2 + t_{GVD}^2 + t_{rx}^2]^{1/2}$$

$$t_{sys} = \left[ t_{tx}^2 + \left( \frac{440 Lq}{B_0} \right)^2 + D^2 \sigma_\lambda^2 L^2 + \left( \frac{350}{B_{rx}} \right)^2 \right]^{1/2}$$

**Example:** For a multimode fiber following parameters are recorded.

LED with drive circuit has rise time of 15 ns.

LED spectral width = 40 nm

Material dispersion related rise time degradation = 21 ns over 6 km link.

Receiver bandwidth = 235 MHz

Modal dispersion rise time = 3.9 nsec

Calculate system rise time.

**Solution :**  $t_{tx} = 15 \text{ nsec}$   $t_{mat} = 21 \text{ nsec}$   $t_{mod} = 3.9 \text{ nsec}$

Now

$$t_{rx} = \frac{350}{B_{rx}}$$

$$t_{rx} = \frac{350}{25}$$

$$t_{rx} = 14 \text{ nsec}$$

Since

$$t_{sys} = \left( \sum_{i=1}^N t_{ri}^2 \right)^{1/2}$$

$$t_{sys} = [15^2 + 21^2 + 3.9^2 + 14^2]^{1/2}$$

$$t_{sys} = 29.61 \text{ nsec}$$

**Example :** A fiber link has following data

Component	BW	Rise time (tr)
Transmitter	200MHz	1.75 nsec
LED (850 nm)	100 MHz	3.50 nsec
Fiber cable	90 MHz	3.89 nsec
PIN detector	350 MHz	1.00 nsec
Receiver	180 MHz	1.94 nsec

Compute the system rise time and bandwidth. Solution :

System rise time is given by

$$t_{sys} = \left( \sum_{i=1}^N t_{ri}^2 \right)^{1/2}$$

$$ct_{sys} = \sqrt{(1.75^2 + 3.5^2 + 3.89^2 + 1.00^2 + 1.94^2)}$$

$$t_{sys} = 5.93 \text{ nsec}$$

System BW is given by

$$BW = \frac{0.35}{5.93 \text{ nsec}}$$

$$BW = \frac{0.35}{t_{sys}}$$

## **WDM**

WDM (Wavelength-division Multiplexing) is the technology of combing a number of wavelengths onto the same fiber simultaneously. A powerful aspect of WDM is that each optical channel can carry any transmission format. WDM increases the capacity of a fiber network dramatically. Thus it is recognized as the Layer 1 transport technology in all tiers of the network. The purpose of this article is to give a brief overview of WDM technology and its applications.

### **NEED OF WDM**

Due to the rapid growth in telecommunication links, high capacity and faster data transmission rates over farther distances are required. To meet these demands, network managers are relying more and more on fiber optics. Typically, there are three methods for expanding capacity: installing more cables, increasing system bitrate to multiplex more signals and wavelength division multiplexing.

The first method, installing more cables, will be preferred in many cases, especially in metropolitan areas, since fiber has become incredibly inexpensive and installation methods more efficient. But when conduit space is not available or major construction is necessary, this may not be the most cost-effective.

Another way for capacity expansion is to increase system bitrate to multiplex more signals. But increasing system bitrate may not prove cost effective either. Since many systems are already running at SONET OC-48 rates (2.5 GB/s) and upgrading to OC-192 (10 GB/s) is expensive, requires changing out all the electronics in a network, and adds 4 times the capacity, may not be necessary.

Thirdly, the WDM has been proved to be the more cost-effective technology. It does not only support current electronics and fibers but also can share fibers by transmitting channels at different wavelengths (colors) of light. Besides, systems are already using fiber optic amplifiers as repeaters also do not require upgrading for most WDM.

From the above comparison of three methods for expanding capacity, we can easily draw a conclusion that WDM is the best solution to meet the demand for more capacity and faster data transmission rates.

Actually, it is not difficult to understand the operating principle of WDM. Consider the fact that you can see many different colors of light: red, green, yellow, blue, etc. The colors are transmitted through the air together and may mix, but they can be easily separated by using a simple device like a prism.

It's like we separate the "white" light from the sun into a spectrum of colors with the prism. WDM is equivalent to the prism in the operating principle. A WDM system uses a multiplexer at the transmitter to joint the several signals together. At the same time, it uses a demultiplexer at the receiver to split them apart, as shown in the following diagram. With the right type of fiber, it is possible to function as an optical add-drop multiplexer.

This technique was originally demonstrated with optical fiber in the early 80s. The first WDM systems combined only two signals. Modern systems can handle up to 160 signals and can thus expand a basic 10 Gbit/s system over a single fiber pair to over 1.6 Tbit/s. Because WDM systems can expand the capacity of the network and accommodate several generations of technology development in optical infrastructure without having to overhaul the backbone network, they are popular with telecommunications companies.

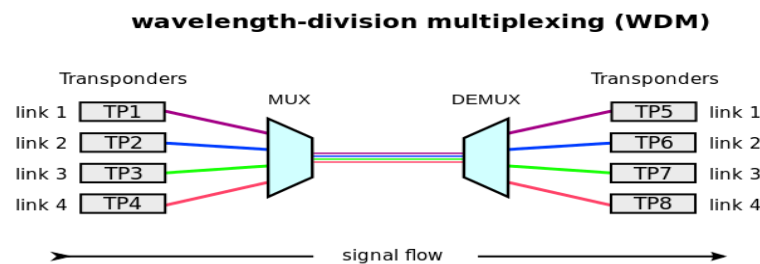

## CWDM VS DWDM

WDM systems are divided into different wavelength patterns: CWDM (Coarse Wavelength Division Multiplexing) and DWDM (Dense Wavelength Division Multiplexing). There are many differences between CWDM and DWDM: spacings, DFB lasers, and transmission distances.

The channel spacings between individual wavelengths transmitted through the same fiber serve as the basis for defining CWDM and DWDM. Typically, the spacing in CWDM systems is 20 nm, while most DWDM systems today offer 0.8 nm (100 GHz) wavelength separation according to the ITU standard.

Due to wider CWDM channel spacing, the number of channels (lambdas) available on the same link is significantly reduced, but the optical interface components do not have to be as precise as DWDM components. CWDM equipment is thus significantly cheaper than DWDM equipment.

Both CWDM and DWDM architectures utilize the DFB (Distributed Feedback Lasers). However, CWDM systems use DFB lasers that are not cooled. These systems typically operate from 0 to 70°C with the laser wavelength drifting about 6 nm over this range. Coupled with the laser wavelength of up to  $\pm 3$  nm, the wavelength drift yields a total wavelength variation of about  $\pm 12$  nm.

DWDM systems, on the other hand, require the larger cooled DFB lasers, because a semiconductor laser wavelength drifts about 0.08 nm/°C with temperature. DFB lasers are cooled to stabilize the wavelength from outside the passband of the multiplexer and demultiplexer filters as the temperature fluctuates in DWDM systems.

Due to the unique attributes of CWDM and DWDM, they are deployed for different transmission distances. Typically, CWDM can travel anywhere up to about 160 km. If we need to transmit the data over a long range, the DWDM system is the best choice. DWDM supports 1550 nm wavelength size, which can be amplified to extend transmission distance to hundreds of kilometers.

## **OPERATIONAL PRINCIPLES OF WDM**

Since the spectral width of a high-quality source occupies only a narrow slice of optical bandwidth, there are many independent operating regions across the spectrum, ranging from the a-band through the L-band, that can be used simultaneously. The original use of WDM was to upgrade the capacity of installed point-to-point transmission links.

This was achieved with wavelengths that were separated from several tens up to 200 nm in order not to impose strict wavelength-tolerance requirements on the different laser sources and the receiving wavelength splitters. Subsequently, the development of lasers that have extremely narrow spectral emission widths allowed wavelengths to be spaced less than a nanometer apart. This is the basis of wavelength-division multiplexing, which simultaneously uses a number of light sources, each emitting at a slightly different peak wavelength.

Each wavelength carries an independent signal, so that the link capacity is increased greatly. The main trick is to ensure that the peak wavelength of a source is spaced sufficiently far from its neighbor so as not to create interference between their spectral extents. Equally important is the requirement that during the operation of a system these peak wavelengths do not drift into the spectral territory occupied by adjacent channels. In addition to maintaining strict control of the wavelength, system designers include an empty guardband between the channels as an operations safety factor.

Thereby the fidelities of the independent messages from each source are maintained for subsequent conversion to electrical signals at the receiving end.

### WDM Operating Regions

The possibility of having an extremely high-capacity link by means of WDM can be seen by examining the characteristics of a high-quality optical source. As an example, a distributed-feedback (DFB) laser has a frequency spectrum on the order of 1 MHz, which is equivalent to a spectral linewidth of 10-5 nm. With such spectral widths, simplex systems make use of only a tiny portion of the transmission bandwidth capability of a fiber. This can be seen from Figure 3.1, which depicts the attenuation of light in a silica fiber as a function of wavelength. The curve shows that the two low-loss regions of a standard G.652 single-mode fiber extend over the O-band wavelengths ranging from about 1270 to 1350 nm (originally called the second window) and from 1480 to 1600nm (originally called the third window). We can view these regions either in terms of spectral width (the wavelength band occupied by the light signal) or by means of optical bandwidth (the frequency band occupied by the light signal).

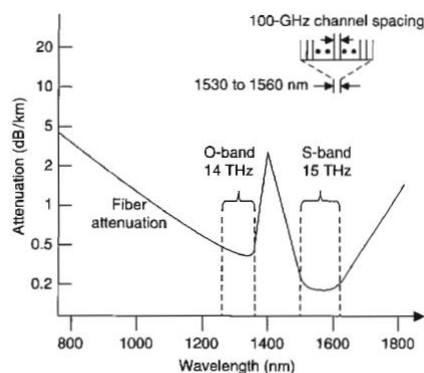

Figure 3.1. Generic representation of the attenuation of light in a silica fiber as a function of wavelength.

To find the optical bandwidth corresponding to a particular spectral width in these regions, we use the fundamental relationship  $c = \lambda \nu$ , which relates the wavelength  $\lambda$  to the carrier frequency  $\nu$ , where  $c$  is the speed of light. Differentiating this, we have

$$\Delta \nu = \frac{c}{\lambda^2} \Delta \lambda \quad (3.1)$$

where the frequency deviation  $\Delta \nu$  corresponds to the wavelength deviation  $\Delta \lambda$  around  $\lambda$ .

Now suppose we have a fiber that has the attenuation characteristic shown in Figure 3.1. From Eq. (3.1) the optical bandwidth is  $\Delta \nu = 14 \text{ THz}$  for a usable spectral band  $\Delta \lambda = 80 \text{ nm}$  in the center of the O-band. Similarly,  $\Delta \nu = 15 \text{ THz}$  for a usable spectral band  $\Delta \lambda = 120 \text{ nm}$  in the low-loss region running from near the beginning of the S-band to almost the end of the L-band. This yields a total available fiber bandwidth of about  $30 \text{ THz}$  in the two low-loss windows.

Prior to about 2000, the peak wavelengths of adjacent light sources typically were restricted to be separated by 0.8 to 1.6 nm (100 to 200 GHz) in a WDM system. This was done to take into account possible drifts of the peak wavelength due to aging or temperature effects, and to give both the manufacturer and the user some leeway in specifying and choosing the precise peak emission wavelength. The next generation of WDM systems specified both narrower and much wider channel spacings depending on the application and on the wavelength region being used. The much narrower spacings thus require strict wavelength control of the optical source. On the other hand, the wider wavelength separations offer inexpensive WDM implementations since wavelength control requirements are relaxed significantly.

### **Generic WDM Link**

The implementation of WDM networks requires a variety of passive and/or active devices to combine, distribute, isolate, add, drop, attenuate, and amplify optical power at different wavelengths. Passive devices require no external electric power or control for their operation, so they have a fixed application in WDM networks. These passive components are used to separate and combine wavelength channels, to divide optical power onto a number of fiber lines, or to tap off part of an optical signal for monitoring purposes.

The performance of active devices can be controlled electronically, thereby providing a large degree of network flexibility, Active WDM components include tunable optical filters, tunable light sources, configurable add/drop multiplexers, dynamic gain equalizers, and optical amplifiers.

Figure 3.2 shows the implementation of a simple WDM link. The transmitting side has a series of independently modulated fixed-wavelength light sources, each of which emits signals at a unique wavelength. Here a multiplexer (popularly called a mux) is needed to combine these optical outputs into a continuous spectrum of signals and couple them onto a single fiber. Within a standard telecommunication link there may be various types of optical amplifiers, a variety of specialized active components (not shown), and passive optical power splitters. The operations and maintenance benefits of PONs are that no active devices are used between the transmitting and receiving endpoints.

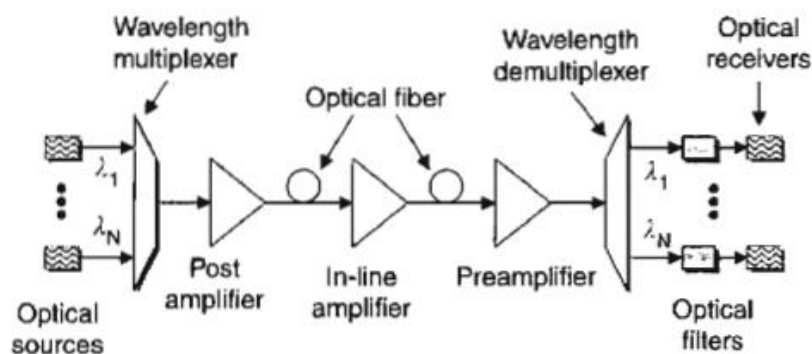

**Figure 3.2.** Implementation of a simple WDM link.

At the receiving end a demultiplexer is required to separate the individual wavelengths of the independent optical signals into appropriate detection channels for signal processing. At the transmitter the basic design challenge is to have the multiplexer provide a low-loss path from each optical source to the multiplexer output. A different requirement exists for the demultiplexer, since photodetectors usually are sensitive over a broad range of wavelengths, which could include all the WDM channels.

To prevent spurious signals from entering a receiving channel, that is, to give good channel isolation of the different wavelengths being used, the demultiplexer must exhibit narrow spectral operation or very stable optical filters with sharp wavelength cutoffs must be used.

The tolerable crosstalk levels between channels can vary widely depending on the application. In general, a -10dB level is not sufficient, whereas a level of -30 dB is acceptable. In principle, any optical demultiplexer can also be used as a multiplexer. For simplicity, the word multiplexer is used as a general term to refer to both combining and separating functions, except when it is necessary to distinguish the two devices or functions.



## Wavelength Division Multiplexing (WDM)

- Optical signals of different wavelength (1300-1600 nm) can propagate without interfering with each other. The scheme of combining a number of wavelengths over a single fiber is called wavelength division multiplexing (WDM).
- Each input is generated by a separate optical source with a unique wavelength. An optical multiplexer couples light from individual sources to the transmitting fiber. At the receiving station, an optical demultiplexer is required to separate the different carriers before photodetection of individual signals. Fig. 7.1.1 shows simple SDM scheme.

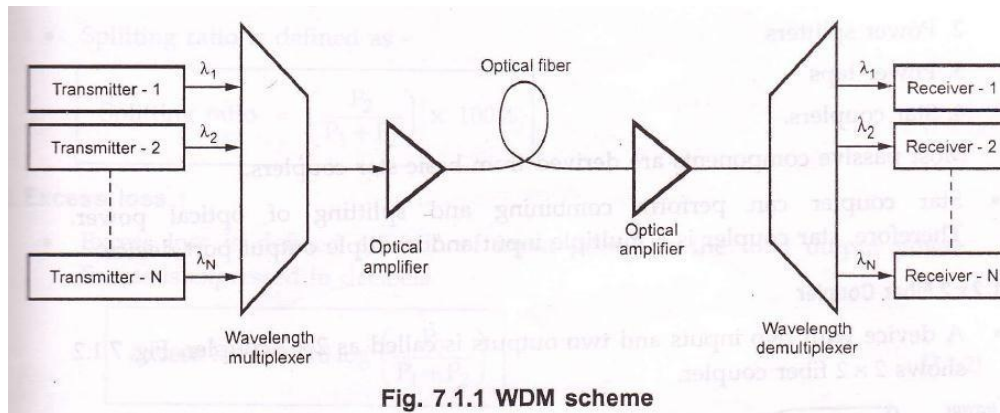

Fig. 7.1.1 WDM scheme

- To prevent spurious signals to enter into receiving channel, the demultiplexer must have narrow spectral operation with sharp wavelength cut-offs. The acceptable limit of crosstalk is – 30 dB.

## Features of WDM

- Important advantages or features of WDM are as mentioned below –
- Capacity upgrade : Since each wavelength supports independent data rate in Gbps.
- Transparency : WDM can carry fast asynchronous, slow synchronous, synchronous analog and digital data.
- Wavelength routing : Link capacity and flexibility can be increased by using multiple wavelength.
- Wavelength switching : WDM can add or drop multiplexers, cross connects and wavelength converters.

## Passive Components

For implementing WDM various passive and active components are required to combine, distribute, isolate and to amplify optical power at different wavelength.

Passive components are mainly used to split or combine optical signals. These components operate in optical domains. Passive components don't need external control for their operation. Passive components are fabricated by using optical fibers by planar optical waveguides. Commonly required passive components are –

- N x N couplers
- Power splitters
- Power taps
- Star couplers.

Most passive components are derived from basic star couplers.

Star coupler can perform combining and splitting of optical power. Therefore, star coupler is a multiple input and multiple output port device.

## Dense Wavelength Division Multiplexing (DWDM)

### DWDM:

- DWDM (Dense wavelength – division multiplexing) is a data transmission technology having very large capacity and efficiency.
- Multiple data channels of optical signals are assigned different wavelengths, and are multiplexed onto one fiber.
- DWDM system consists of transmitters, multiplexers, optical amplifier and demultiplexer. Fig. 7.2.1 shows typical application of DWDM system.

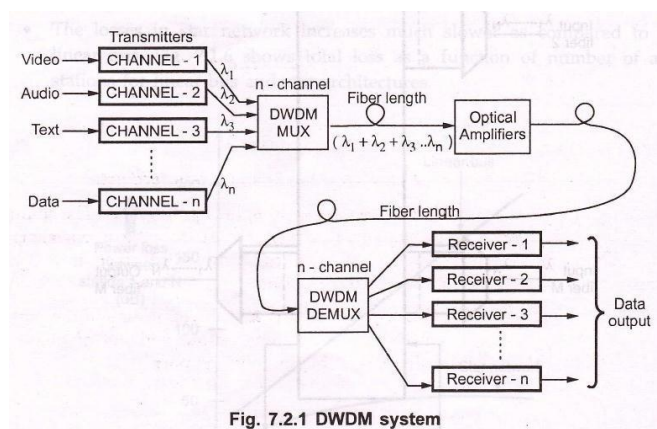

Fig. 7.2.1 DWDM system

- DWDM uses single mode fiber to carry multiple light waves of different frequencies.
- DWDM systems use Erbium – Doped Fiber Amplifiers (EDFA) for its long haul applications, and to overcome the effects of dispersion and attenuation channel spacing of 100 GHz is used.

DWDM is short for dense wavelength division multiplexing. It is an optical multiplexing technology used to increase bandwidth over existing fiber networks. DWDM works by combining and transmitting multiple signals simultaneously at different wavelengths on the same fiber. It has revolutionized the transmission of information over long distances. DWDM can be divided into passive DWDM and active DWDM. This article will detail these two DWDM systems.

## Passive DWDM

Passive DWDM systems have no active components. The line functions only due to the optical budget of transceivers used. No optical signal amplifiers and dispersion compensators are used. Passive DWDM systems have a high channel capacity and potential for expansion, but the transmission distance is limited to the optical budget of transceivers used. The main application of passive DWDM system is metro networks and high speed communication lines with a high channel capacity.

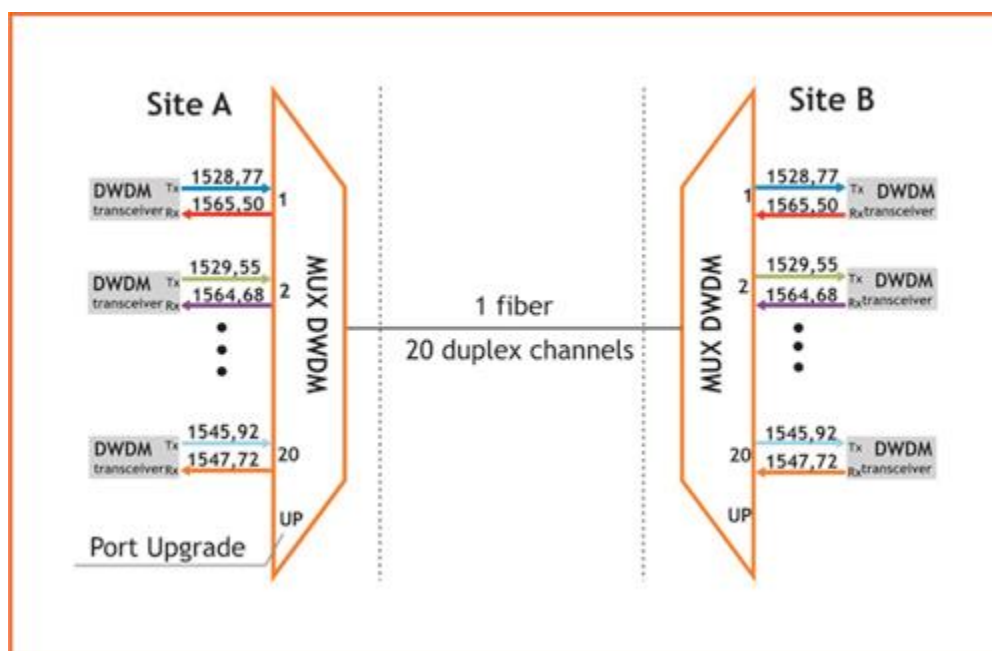

## Active DWDM

Active DWDM systems commonly refer to as a transponder-based system. They offer a way to transport large amounts of data between sites in a data center interconnect setting. The transponder takes the outputs of the SAN or IP switch format, usually in a short wave 850nm or long wave 1310nm format, and converts them through an optical-electrical-optical (OEO) DWDM conversion. When creating long-haul DWDM networks, several [EDFA amplifiers](#) are installed sequentially in the line. The number of amplifiers in one section is limited and depends on the optical cable type, channel count, data transmission rate of each channel, and permissible OSNR value.

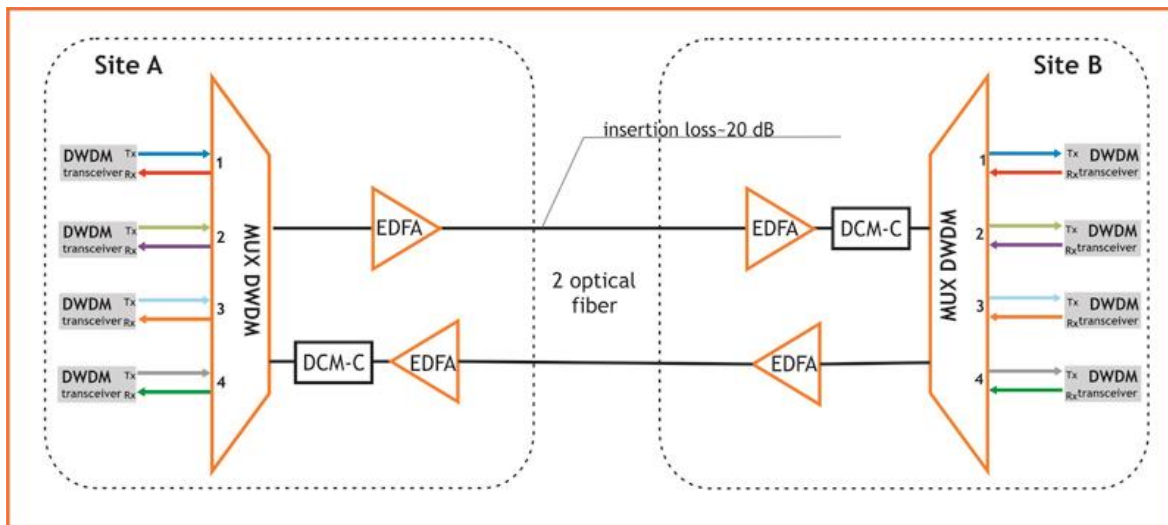

The possible length of lines when using active DWDM system is determined not only with installed optical amplifiers and the OSNR value, but also with the influence of chromatic dispersion—the distortion of transmitted signal impulses, on transmitted signals. At the design stage of the DWDM network project, permissible values of chromatic dispersion for the transceivers are taken into account, and, if necessary, chromatic [dispersion compensation modules](#) (DCM) are included in the line. DCM introduces additional attenuation into the line, which leads to a reduction of the amplified section length.

At this stage, a basic DWDM system contains several main components:

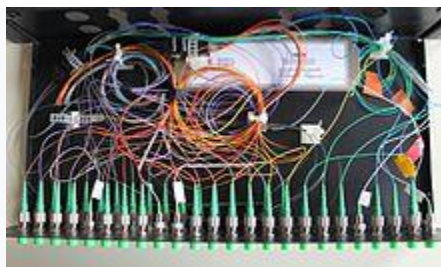

WDM multiplexer for DWDM communications

1. A DWDM **terminal multiplexer**. The terminal multiplexer contains a wavelength-converting transponder for each data signal, an optical multiplexer and where necessary an optical amplifier (EDFA). Each wavelength-converting transponder receives an optical data signal from the client-layer, such as Synchronous optical networking [SONET /SDH] or another type of data signal, converts this signal into the electrical domain and re-transmits the signal at a specific wavelength using a 1,550 nm band laser. These data signals are then combined together into a multi-wavelength optical signal using an optical multiplexer, for transmission over a single fiber (e.g., SMF-28 fiber). The terminal multiplexer may or may not also include a local transmit EDFA for power amplification of the multi-wavelength optical signal. In the mid-1990s DWDM systems contained 4 or 8 wavelength-converting transponders; by 2000 or so, commercial systems capable of carrying 128 signals were available.

2. An **intermediate line repeater** is placed approximately every 80–100 km to compensate for the loss of optical power as the signal travels along the fiber. The 'multi-wavelength optical signal' is amplified by an EDFA, which usually consists of several amplifier stages.
3. An **intermediate optical terminal**, or **optical add-drop multiplexer**. This is a remote amplification site that amplifies the multi-wavelength signal that may have traversed up to 140 km or more before reaching the remote site. Optical diagnostics and telemetry are often extracted or inserted at such a site, to allow for localization of any fiber breaks or signal impairments. In more sophisticated systems (which are no longer point-to-point), several signals out of the multi-wavelength optical signal may be removed and dropped locally.
4. A DWDM **terminal demultiplexer**. At the remote site, the terminal de-multiplexer consisting of an optical de-multiplexer and one or more wavelength-converting transponders separates the multi-wavelength optical signal back into individual data signals and outputs them on separate fibers for client-layer systems (such as SONET/SDH). Originally, this de-multiplexing was performed entirely passively, except for some telemetry, as most SONET systems can receive 1,550 nm signals. However, in order to allow for transmission to remote client-layer systems (and to allow for digital domain signal integrity determination) such de-multiplexed signals are usually sent to O/E/O output transponders prior to being relayed to their client-layer systems. Often, the functionality of output transponder has been integrated into that of input transponder, so that most commercial systems have transponders that support bi-directional interfaces on both their 1,550 nm (i.e., internal) side, and external (i.e., client-facing) side. Transponders in some systems supporting 40 GHz nominal operation may also perform forward error correction (FEC) via digital wrapper technology, as described in the ITU-T G.709 standard.
5. **Optical Supervisory Channel (OSC)**. This is data channel which uses an additional wavelength usually outside the EDFA amplification band (at 1,510 nm, 1,620 nm, 1,310 nm or another proprietary wavelength). The OSC carries information about the multi-wavelength optical signal as well as remote conditions at the optical terminal or EDFA site. It is also normally used for remote software upgrades and user (i.e., network operator) Network Management information. It is the multi-wavelength analogue to SONET's DCC (or supervisory channel). ITU standards suggest that the OSC should utilize an OC-3 signal structure, though some vendors have opted to use 100 megabit Ethernet or another signal format. Unlike the 1550 nm multi-wavelength signal containing client data, the OSC is always terminated at intermediate amplifier sites, where it receives local information before re-transmission.

## **Optical Network**

An Optical Network is basically a communication network used for the exchange of information through an optical fiber cable between one end to another. It is one of the quickest networks used for data communication.

As we already know that data signal through an optical fiber is transmitted in the form of light pulses. So, optical networks are used in order to have optical signal transmission.

Now, the question arises that what is the need for the optical network when we have other communicating networks.

So, the answer to this question basically relies on the ease of transmitting the signal in the form of light pulses. Today's internet era is based on fiber cable and only the optical signals can be transmitted through these cables. Thus, the need for optical network emerges. As we know that transmission through fiber cable is an easier task due to the low production cost of the cable. Along with that, a fiber cable permits large data carrying capacity and longer distance transmission than other cables. Thus, we use fiber cables and hence, the optical network is an important aspect of the communication system.

### Elements of optical network

An optical network is basically composed of the following elements:

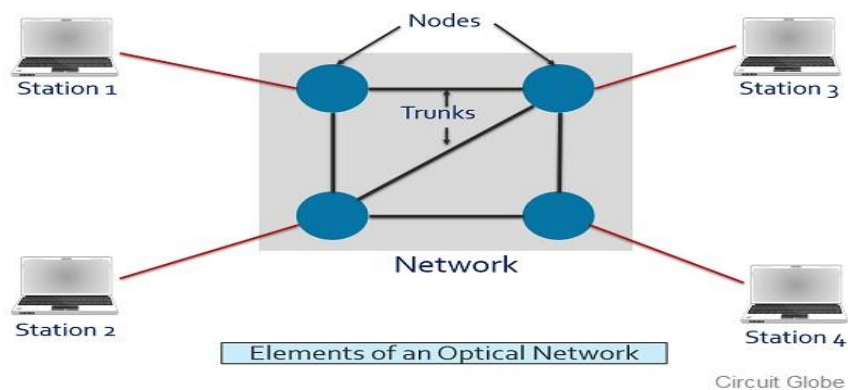

**Stations:** Stations in an optical network serve as the source and destination of the information being transmitted and received. Stations are basically those devices that are used by the users of the network. For example, a computer or any other telecommunication device.

**Trunk:** A trunk is basically a transmission line i.e., optical fiber cable in order to transmit the optical signal. A network is composed of one or multiple trunks for signal transmission over large distance.

**Node:** Node is nothing but acts as a hub for multiple transmission lines inside the network. In case of a single transmission line, an optical network does not require nodes, as in this case stations at both the ends can be directly connected to the fiber cables.

**Topology:** When multiple fiber cables are employed in an optical network, then these are connected through nodes. But the way in which the multiple nodes are connected together denotes the topology of the network.

**Router:** A router is basically placed inside an optical network that provides a suitable path for signal transmission.

## Optical Network Topologies

As we have already discussed in the previous section that topology is the arrangement of multiple optical fiber transmission lines in an optical network. So, let us now move forward to understand the various topology configurations:

### Types Of Topology

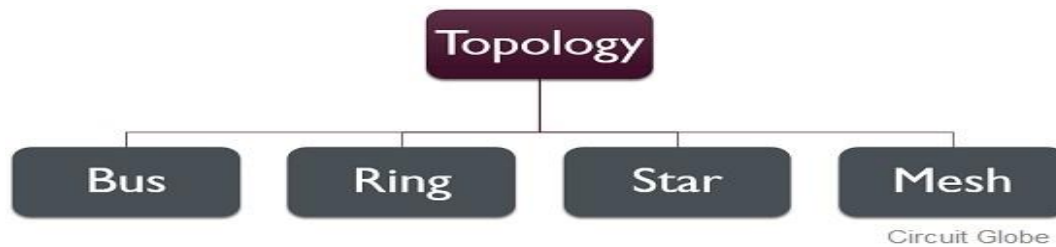

**Bus Topology:** In a bus topology, the various nodes are connected through a single trunk line with the help of optical couplers. This allows a convenient as well as a cost-effective method to transmit the signal. However, in a bus topology, it is difficult to determine the faulted node as well as it also takes time to restore the transmitted signal from that particular node.

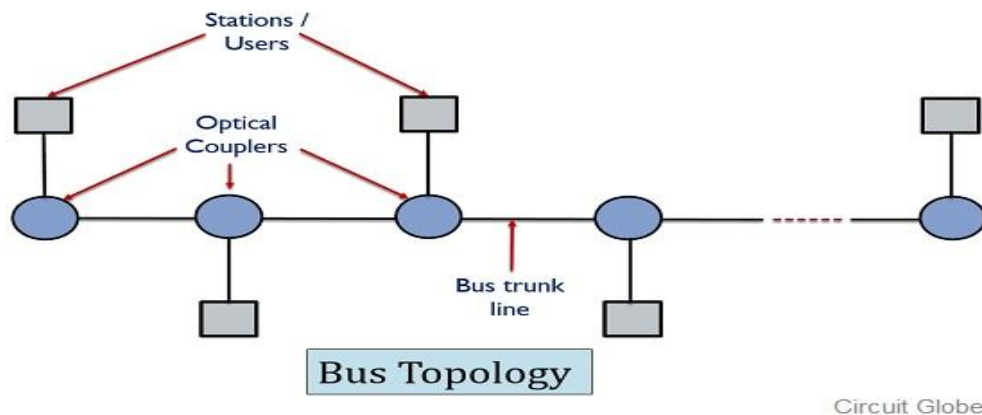

**Ring Topology:** In a ring topology, one single node is joined to its neighbouring node thereby forming a closed path. So, the transmitted information in the form of light is sent from one node to another. Also, optical couplers are installed within the network in order to couple the transmitted optical signal from one node to another.



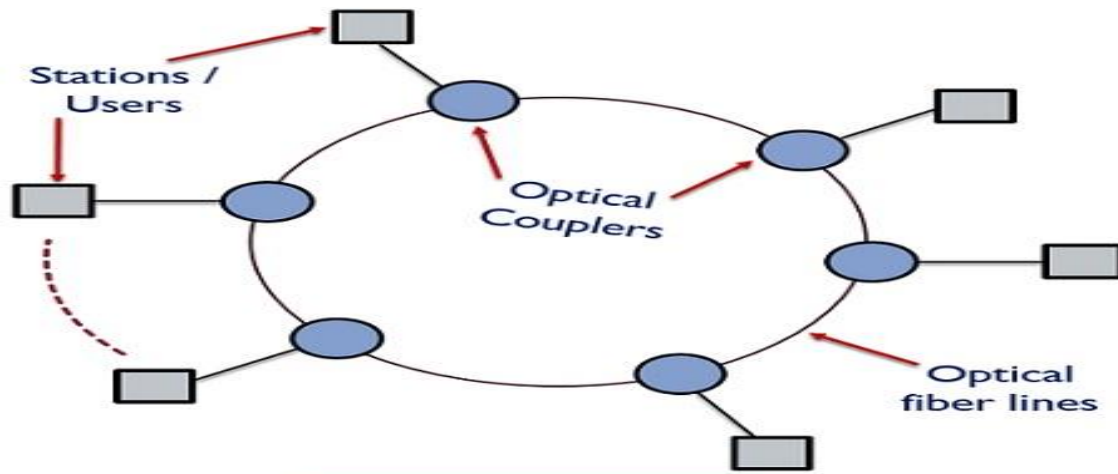

Ring Topology

Circuit Globe

**Star Topology:** In star connection, the various nodes of the network are connected together with a single central hub. This central hub can be active or passive network. This central hub then controls and directs the transmitted optical signal inside the optical network.

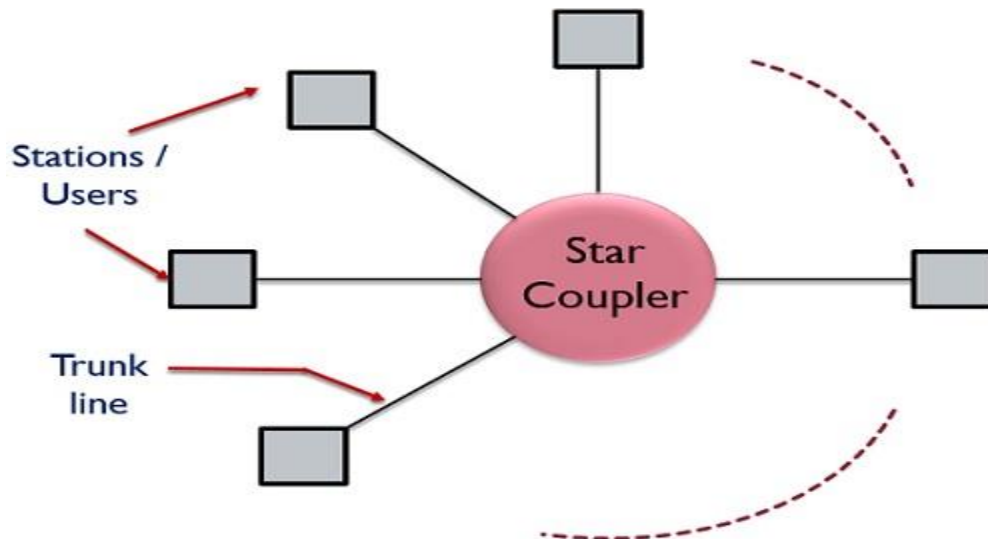

Star Topology

Circuit Globe

**Mesh Topology:** In a mesh topology, an arbitrary connection is formed between the nodes in the network. This point to point connection can be changed according to the application. This shows the flexible nature of star topology as in case of failure of one node, others can be used for signal transmission.



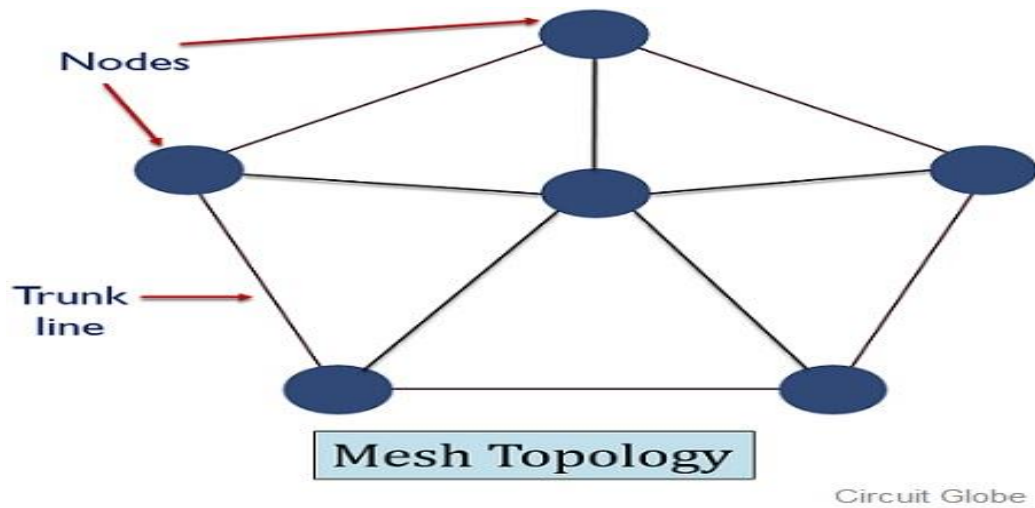

Basically, in mesh connection, failure of any link or node is generated then firstly that particular failure is detected and then the signal traffic is diverted from failed node to another link inside the connection.

### Categories of Optical Network

The categories of optical network are based on the area that connects the user of the network. These are classified as:

**Local Area Network (LAN):** Basically a LAN connection provides the interconnection of users that are present in localized areas like a building, a department or an office etc.

The example of networking topology of LAN is Ethernet. As in LAN, users are permitted to share the resources together like servers etc. These are personally owned by an organization. It is quite inexpensive.

**Campus network:** This network category is formed by the interconnection of multiple LAN's. This is basically extended to a large level but is still confined within a localized area. It is also governed by a single organization.

The examples of campus network are university campus, a government organization, or a medical centre etc.

**Metropolitan Area Network (MAN):** It is also known as a metro network and covers a greater area than a campus network. It permits the interconnection of several buildings that are present in different cities.

Due to its large operating area, MAN is controlled by several communication organizations.

**Wide Area Network (WAN):** Unlike MAN, a WAN provides interconnection of users from neighbouring cities as well as cross-country regions. It is employed to establish communication over a large geographical distance and is controlled and maintained by some private organizations or telecommunication service providers.

## Advantages of Optical Network

Using an optical networking system is highly advantageous. The advantages are as follows:

- An optical transmission system supports high bandwidth.
- The transmitted signal can be transmitted to longer distances.
- This networking system is more flexible than other transmission systems.

So, we can say an optical network provides better signal transmission capability to longer distances thus is widely used nowadays.

## Synchronous Optical Network (SONET)

SONET stands for Synchronous Optical Network. SONET is a communication protocol, developed by Bellcore – that is used to transmit a large amount of data over relatively large distances using optical fibre. With SONET, multiple digital data streams are transferred at the same time over the optical fibre.

### Key Points:

- Developed by Bellcore
- Used in North America
- Standardized by ANSI (American National Standards Institute)
- Similar to SDH (Synchronous Digital Hierarchy) which is used in Europe and Japan.

A single clock (Primary Reference Clock, PRC) handles the timing of transmission of signals & equipments across the entire network.

### SONET Network Elements:

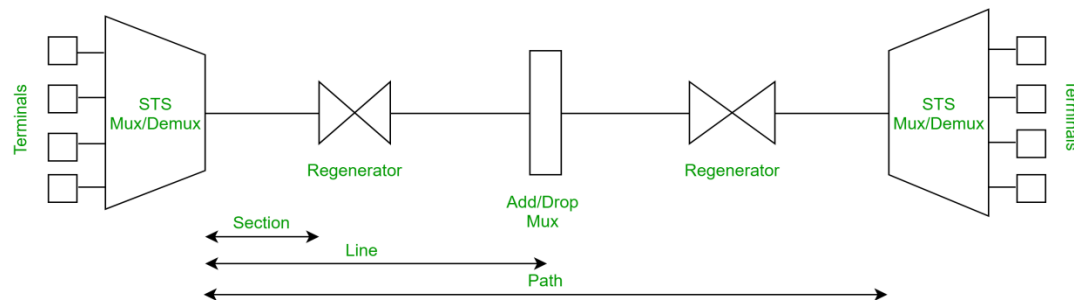

### STS Multiplexer:

- Performs multiplexing of signals
- Converts electrical signal to optical signal

### STS Demultiplexer:

- Performs demultiplexing of signals
- Converts optical signal to electrical signal

### Regenerator:

It is a repeater, that takes an optical signal and regenerates (increases the strength) it.

### Add/Drop Multiplexer:

It allows adding signals coming from different sources into a given path or removing a signal.

SONET is used to convert electrical signal into optical signal so that it can travel longer distances.

### SONET Connections:

- **Section:** Portion of network connecting two neighbouring devices.
- **Line:** Portion of network connecting two neighbouring multiplexers.
- **Path:** End-to-end portion of the network.

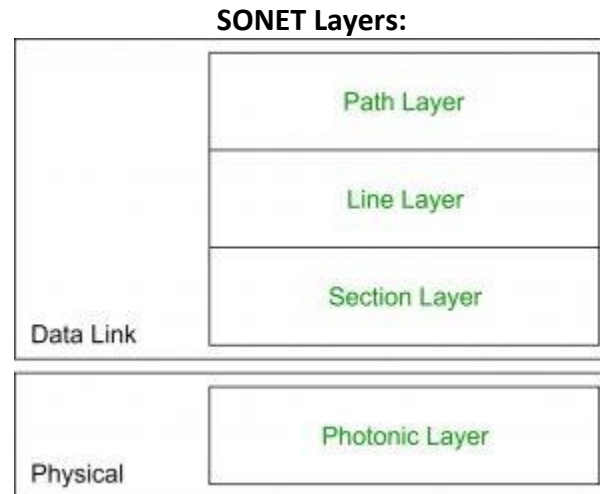

SONET includes four functional layers:

1. **Path Layer:**
    - It is responsible for the movement of signal from its optical source to its optical destination.
    - STS Mux/Demux provides path layer functions.
  2. **Line Layer:**
    - It is responsible for the movement of signal across a physical line.
    - STS Mux/Demux and Add/Drop Mux provides Line layer functions.
  3. **Section Layer:**
    - It is responsible for the movement of signal across a physical section.
    - Each device of network provides section layer functions.
  4. **Photonic Layer:**
    - It corresponds to the physical layer of the OSI model.
1. It includes physical specifications for the optical fibre channel (presence of light = 1 and absence of light = 0).
  2. **Advantages of SONET:**
    - Transmits data to large distances
    - Low electromagnetic interference
    - High data rates
    - Large Bandwidth