

ELECTRO MAGNETIC FIELDS LECTURE NOTES

**B.TECH
(II YEAR - I SEM)
(2019-20)**

Prepared by:

M.KUMARA SWAMY., Asst.Prof

Department of Electrical & Electronics Engineering



**MALLA REDDY COLLEGE
OF ENGINEERING & TECHNOLOGY**

(Autonomous Institution - UGC, Govt. of India)

Recognized under 2(f) and 12 (B) of UGC ACT 1956

(Affiliated to JNTUH, Hyderabad, Approved by AICTE - Accredited by NBA & NAAC - 'A' Grade - ISO 9001:2015 Certified)
Maisammaguda, Dhulapally (Post Via. Kompally), Secunderabad - 500100, Telangana State, India

ELECTRO MAGNETIC FIELDS

Objectives:

- To introduce the concepts of electric field, magnetic field.
- Applications of electric and magnetic fields in the development of the theory for power transmission lines and electrical machines.

UNIT – I Electrostatics:

Electrostatic Fields – Coulomb’s Law – Electric Field Intensity (EFI) – EFI due to a line and a surface charge – Work done in moving a point charge in an electrostatic field – Electric Potential – Properties of potential function – Potential gradient – Gauss’s law – Application of Gauss’s Law – Maxwell’s first law, $\text{div}(\mathbf{D}) = \rho_v$ – Laplace’s and Poisson’s equations . Electric dipole – Dipole moment – potential and EFI due to an electric dipole.

UNIT – II Dielectrics & Capacitance:

Behavior of conductors in an electric field – Conductors and Insulators – Electric field inside a dielectric material – polarization – Dielectric – Conductor and Dielectric – Dielectric boundary conditions – Capacitance – Capacitance of parallel plates – spherical co-axial capacitors. Current density – conduction and Convection current densities – Ohm’s law in point form – Equation of continuity

UNIT – III Magneto Statics:

Static magnetic fields – Biot-Savart’s law – Magnetic field intensity (MFI) – MFI due to a straight current carrying filament – MFI due to circular, square and solenoid current Carrying wire – Relation between magnetic flux and magnetic flux density – Maxwell’s second Equation, $\text{div}(\mathbf{B}) = 0$, Ampere’s Law & Applications: Ampere’s circuital law and its applications viz. MFI due to an infinite sheet of current and a long current carrying filament – Point form of Ampere’s circuital law – Maxwell’s third equation, $\text{Curl}(\mathbf{H}) = \mathbf{J}_c$

UNIT – IV Force in Magnetic fields and Magnetic Potential:

Magnetic force Moving charges in a Magnetic field – Lorentz force equation – force on a current element in a magnetic field – Force on a straight and a long current carrying conductor in a magnetic field – Force between two straight long and parallel current carrying conductors – Magnetic dipole and dipole moment – a differential current loop as a magnetic dipole . Magnetic potential and its limitations – vector magnetic potential and its properties . Self and Mutual inductance – Neumann’s formulae – determination of self-inductance of a solenoid and toroid and mutual inductance between a straight long wire and a square loop wire in the same plane – energy stored and density in a magnetic field.

UNIT – V Time Varying Fields:

Time varying fields – Faraday’s laws of electromagnetic induction – Its integral and point forms – Maxwell’s fourth equation, $\text{Curl}(\mathbf{E}) = -d\mathbf{B}/dt$ – Statically and Dynamically induced EMFs – Simple problems -Modification of Maxwell’s equations for time varying fields – Displacement current

TEXT BOOKS:

1. "William H. Hayt & John. A. Buck", "Engineering Electromagnetics", Mc. Graw-Hill Companies, 7th Edition, 2009.
2. "Sadiku", "Electromagnetic Fields", Oxford Publications, 4th Edition, 2009.

REFERENCE BOOKS:

1. "CR Paul and S. A. Nasar", "Introduction to Electromagnetic", Mc-Graw Hill Publications, 3rd Edition, 1997.
2. "Nathan Ida", "Engineering Electromagnetic", Springer (India) Pvt. Ltd. 2nd Edition, 2015.
3. "D J Griffiths", "Introduction to Electro Dynamics", Prentice-Hall of India Pvt. Ltd, 3rd edition, 1999.
4. "J. D Kraus", "Electromagnetics", Mc Graw-Hill Inc. 4th edition, 1992.

Course Outcomes: upon completion of course, student will be able to Apply vector calculus to static electric – magnetic fields.

1. Compute the force, fields & Energy for different charge & current configurations & evaluate capacitance and inductance.
2. Analyze Maxwell's equation in different forms (Differential and integral) in Electrostatic, Magnetic time varying fields.
3. Ability to solve the problems in different EM fields.
4. Ability to Analyse moving charges on Magnetic fields.
5. Ability to Solve Electromagnetic Relation using Maxwell Formulae.

UNIT-I

Electrostatic Fields

- Coulomb's Law
- Electric Field Intensity –Fields due to line and surface Charge Distributions
- Work done in moving a point charge in an electrostatic field
- Electrostatic Potential & Properties of potential function – Potential gradient
- Gauss's law – Application of Gauss's Law
- Maxwell's first law
- Divergence
- Laplace's and Poisson's equations – Solution of Laplace's equation in one variable
- Electric dipole – Dipole moment – potential and EFI due to an electric dipole
- Torque on an Electric dipole in an electric field
- Behavior of conductors in an electric field – Conductors and Insulators

Introduction:

The electric charge is a fundamental property of matter and charge exist in integral multiple of electronic charge. Electrostatics can be defined as the study of electric charges at rest. Electric fields have their sources in electric charges.

(Note: Almost all real electric fields vary to some extent with time. However, for many problems, the field variation is slow and the field may be considered as static. For some other cases spatial distribution is nearly same as for the static case even though the actual field may vary with time. Such cases are termed as quasi-static.)

In this chapter we first study two fundamental laws governing the electrostatic fields, viz, (1) Coulomb's Law and (2) Gauss's Law. Both these law have experimental basis. Coulomb's law is applicable in finding electric field due to any charge distribution, Gauss's law is easier to use when the distribution is symmetrical

Coulomb's Law :

Statement:

Coulomb's Law states that the force between two point charges Q1 and Q2 is directly proportional to the product of the charges and inversely proportional to the square of the distance between them.

Point charge is a hypothetical charge located at a single point in space. It is an idealized model of a particle having an electric charge.

Mathematically,

$$F = \frac{kQ_1Q_2}{R^2} \quad k = \frac{1}{4\pi\epsilon_0}$$

Where k is the proportionality constant. And ϵ_0 , is called the permittivity of free space

In SI units, Q1 and Q2 are expressed in Coulombs(C) and R is in meters.

Force F is in Newton's (N)

(We are assuming the charges are in free space. If the charges are any other dielectric medium, we

will use $\epsilon = \epsilon_0\epsilon_r$ instead where ϵ_r is called the relative permittivity or the dielectric constant of the medium).

Therefore
$$F = \frac{1}{4\pi\epsilon_0} \frac{Q_1 Q_2}{R^2} \dots\dots\dots (1)$$

As shown in the Figure 1 let the position vectors of the point charges Q1 and Q2 are given by \vec{r}_1 and \vec{r}_2 . Let \vec{F}_{12} represent the force on Q1 due to charge Q2.

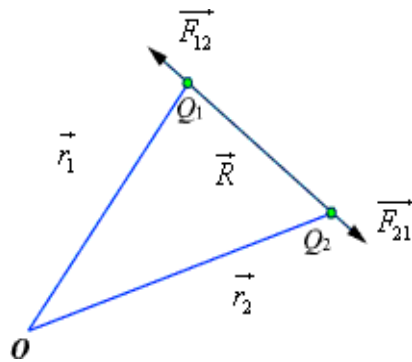

Fig 1: Coulomb's Law

The charges are separated by a distance of $R = |\vec{r}_1 - \vec{r}_2| = |\vec{r}_2 - \vec{r}_1|$. We define the unit vectors as

$$\hat{a}_{12} = \frac{(\vec{r}_2 - \vec{r}_1)}{R} \quad \text{and} \quad \hat{a}_{21} = \frac{(\vec{r}_1 - \vec{r}_2)}{R} \dots\dots\dots (2)$$

\vec{F}_{12} can be defined as
$$\vec{F}_{12} = \frac{Q_1 Q_2}{4\pi\epsilon_0 R^2} \hat{a}_{12} = \frac{Q_1 Q_2}{4\pi\epsilon_0 R^2} \frac{(\vec{r}_2 - \vec{r}_1)}{|\vec{r}_2 - \vec{r}_1|}$$

Similarly the force on Q_1 due to charge Q_2 can be calculated and if \vec{F}_{21} represents this force then we can write $\vec{F}_{21} = -\vec{F}_{12}$

Force Due to ‘N ‘no.of point charges:

When we have a number of point charges, to determine the force on a particular charge due to all other charges, we apply principle of superposition. If we have N number of charges Q_1, Q_2, \dots, Q_N located respectively at the points represented by the position vectors $\vec{r}_1, \vec{r}_2, \dots, \vec{r}_N$, the force experienced by a charge Q located at \vec{r} is given by,

$$\vec{F} = \frac{Q}{4\pi\epsilon_0} \sum_{i=1}^N \frac{Q_i(\vec{r} - \vec{r}_i)}{|\vec{r} - \vec{r}_i|^3} \dots\dots\dots(3)$$

Electric Field intensity:

The electric field intensity or the electric field strength at a point is defined as the force per unit charge.

That is

$$\vec{E} = \lim_{Q \rightarrow 0} \frac{\vec{F}}{Q} \quad \text{or,} \quad \vec{E} = \frac{\vec{F}}{Q} \dots\dots\dots(4)$$

The electric field intensity E at a point r (observation point) due a point charge Q located at \vec{r}' (source point) is given by:

$$\vec{E} = \frac{Q(\vec{r} - \vec{r}')}{4\pi\epsilon_0 |\vec{r} - \vec{r}'|^3} \dots\dots\dots(5)$$

For a collection of N point charges Q_1, Q_2, \dots, Q_N located at $\vec{r}'_1, \vec{r}'_2, \dots, \vec{r}'_N$, the electric field intensity at point \vec{r}' is obtained as

$$\vec{E} = \frac{1}{4\pi\epsilon_0} \sum_{i=1}^N \frac{Q_k(\vec{r} - \vec{r}'_i)}{|\vec{r} - \vec{r}'_i|^3} \dots\dots\dots(6)$$

The expression (6) can be modified suitably to compute the electric field due to a continuous distribution of charges.

In figure 2 we consider a continuous volume distribution of charge (t) in the region denoted as the source region.

For an elementary charge $dQ = \rho(\vec{r}')dv'$, i.e. considering this charge as point charge, we can write the field expression as:

$$d\vec{E} = \frac{dQ(\vec{r} - \vec{r}')}{4\pi\epsilon_0 |\vec{r} - \vec{r}'|^3} = \frac{\rho(\vec{r}')dv'(\vec{r} - \vec{r}')}{4\pi\epsilon_0 |\vec{r} - \vec{r}'|^3} \dots\dots\dots(7)$$

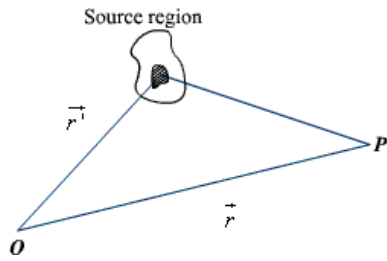

Fig 2: Continuous Volume Distribution of Charge

When this expression is integrated over the source region, we get the electric field at the point P due to this distribution of charges. Thus the expression for the electric field at P can be written as:

$$\vec{E}(\vec{r}) = \int_V \frac{\rho(\vec{r}')(\vec{r} - \vec{r}')}{4\pi\epsilon_0 |\vec{r} - \vec{r}'|^3} dV' \dots\dots\dots(8)$$

Similar technique can be adopted when the charge distribution is in the form of a line charge density or a surface charge density.

$$\vec{E}(\vec{r}) = \int_L \frac{\rho_L(\vec{r}')(\vec{r} - \vec{r}')}{4\pi\epsilon_0 |\vec{r} - \vec{r}'|^3} dl' \dots\dots\dots(9)$$

$$\vec{E}(\vec{r}) = \int_S \frac{\rho_s(\vec{r}')(\vec{r} - \vec{r}')}{4\pi\epsilon_0 |\vec{r} - \vec{r}'|^3} dS' \dots\dots\dots(10)$$

Electric flux density:

As stated earlier electric field intensity or simply ‘Electric field’ gives the strength of the field at a particular point. The electric field depends on the material media in which the field is being considered. The flux density vector is defined to be independent of the material media (as we’ll see that it relates to the charge that is producing it).For a linear isotropic medium under consideration; the flux density vector is defined as:

$$\vec{D} = \epsilon\vec{E} \dots\dots\dots(11)$$

We define the electric flux as

$$\psi = \int_S \vec{D} \cdot d\vec{s} \dots\dots\dots(12)$$

Gauss's Law:

Gauss's law is one of the fundamental laws of electromagnetism and it states that the total electric flux through a closed surface is equal to the total charge enclosed by the surface.

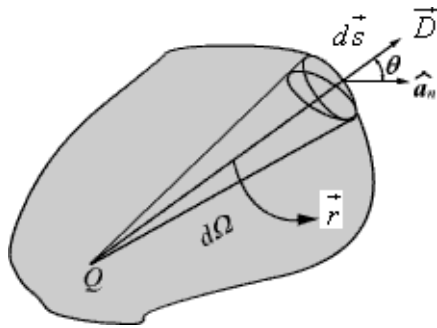

Fig 3: Gauss's Law

Let us consider a point charge Q located in an isotropic homogeneous medium of dielectric constant . The flux density at a distance r on a surface enclosing the charge is given by

$$\vec{D} = \epsilon \vec{E} = \frac{Q}{4\pi r^2} \hat{a}_r \dots\dots\dots(13)$$

If we consider an elementary area ds , the amount of flux passing through the elementary area is given by

$$d\psi = \vec{D} \cdot ds = \frac{Q}{4\pi r^2} ds \cos \theta \dots\dots\dots(14)$$

But $\frac{ds \cos \theta}{r^2} = d\Omega$, is the elementary solid angle subtended by the area ds at the location of Q .

Therefore we can write
$$d\psi = \frac{Q}{4\pi} d\Omega$$

$$\psi = \oint_S d\psi = \frac{Q}{4\pi} \oint_S d\Omega = Q$$

For a closed surface enclosing the charge, we can write

Which can seen to be same as what we have stated in the definition of Gauss's Law.

Application of Gauss's Law:

Gauss's law is particularly useful in computing \vec{E} or \vec{D} where the charge distribution has some

symmetry. We shall illustrate the application of Gauss's Law with some examples.

1. An infinite line charge

As the first example of illustration of use of Gauss's law, let consider the problem of determination of the electric field produced by an infinite line charge of density λ C/m. Let us consider a line charge positioned along the z -axis as shown in Fig. 4(a) (next slide). Since the line charge is assumed to be infinitely long, the electric field will be of the form as shown in Fig. 4(b) (next slide).

If we consider a close cylindrical surface as shown in Fig. 2.4(a), using Gauss's theorem we can write,

$$\rho_l \lambda = Q = \oint_S \epsilon_0 \vec{E} \cdot d\vec{s} = \int_{S_1} \epsilon_0 \vec{E} \cdot d\vec{s} + \int_{S_2} \epsilon_0 \vec{E} \cdot d\vec{s} + \int_{S_3} \epsilon_0 \vec{E} \cdot d\vec{s} \dots\dots\dots(15)$$

Considering the fact that the unit normal vector to areas S_1 and S_3 are perpendicular to the electric field, the surface integrals for the top and bottom surfaces evaluates to zero. Hence we can write,

$$\rho_l \lambda = \epsilon_0 E \cdot 2\pi r l$$

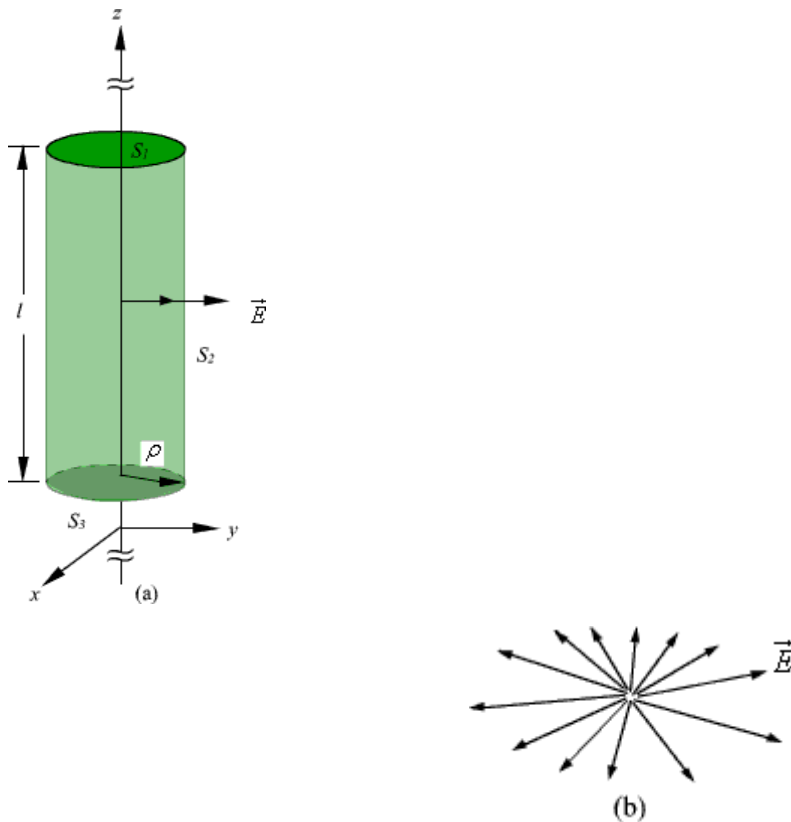

Fig 4: Infinite Line Charge

$$\vec{E} = \frac{\rho_L}{2\pi\epsilon_0 r} \hat{a}_r \dots\dots\dots(16)$$

2. Infinite Sheet of Charge

As a second example of application of Gauss's theorem, we consider an infinite charged sheet covering the x - z plane as shown in figure 5. Assuming a surface charge density of ρ_s for the infinite surface charge, if we consider a cylindrical volume having sides Δs placed symmetrically as shown in figure 5, we can write:

$$\oint_S \vec{D} \cdot d\vec{s} = 2D\Delta s = \rho_s \Delta s$$

$$\therefore \vec{E} = \frac{\rho_s}{2\epsilon_0} \hat{a}_y \dots\dots\dots(17)$$

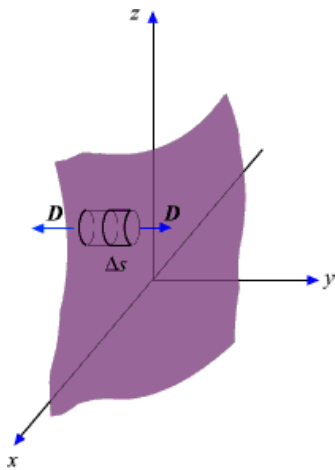

Fig 5: Infinite Sheet of Charge

It may be noted that the electric field strength is independent of distance. This is true for the infinite plane of charge; electric lines of force on either side of the charge will be perpendicular to the sheet and extend to infinity as parallel lines. As number of lines of force per unit area gives the strength of the field, the field becomes independent of distance. For a finite charge sheet, the field will be a function of distance.

3. Uniformly Charged Sphere

Let us consider a sphere of radius r_0 having a uniform volume charge density of ρ_v C/m³. To determine \vec{D} everywhere, inside and outside the sphere, we construct Gaussian surfaces of radius $r < r_0$ and $r > r_0$ as shown in Fig. 6 (a) and Fig. 6(b).

For the region $r \leq r_0$; the total enclosed charge will be

$$Q_{en} = \rho_v \frac{4}{3} \pi r^3 \dots\dots\dots(18)$$

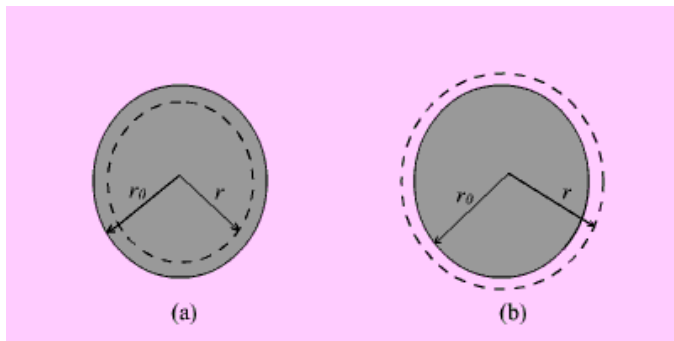

Fig 6: Uniformly Charged Sphere

By applying Gauss's theorem,

$$\oint_S \vec{D} \cdot d\vec{s} = \int_{\phi=0}^{2\pi} \int_{\theta=0}^{\pi} D_r r^2 \sin \theta d\theta d\phi = 4\pi r^2 D_r = Q_{en} \dots\dots\dots (19)$$

Therefore

$$\vec{D} = \frac{r}{3} \rho_v \hat{a}_r \quad 0 \leq r \leq r_0 \dots\dots\dots (20)$$

For the region $r \geq r_0$; the total enclosed charge will be

$$Q_{en} = \rho_v \frac{4}{3} \pi r_0^3 \dots\dots\dots (21)$$

By applying Gauss's theorem,

$$\vec{D} = \frac{r_0^3}{3r^2} \rho_v \hat{a}_r \quad r \geq r_0 \dots\dots\dots (22)$$

Electrostatic Potential:

In the previous sections we have seen how the electric field intensity due to a charge or a charge distribution can be found using Coulomb's law or Gauss's law. Since a charge placed in the vicinity of another charge (or in other words in the field of other charge) experiences a force, the movement of the charge represents energy exchange. Electrostatic potential is related to the work done in carrying a charge from one point to the other in the presence of an electric field. Let us suppose that we wish to move a positive test charge Δq from a point P to another point Q as shown in the Fig. 8. The force at any point along its path would cause the particle to accelerate and move it out of the region if unconstrained. Since we are dealing with an electrostatic case, a force equal to the negative of that acting on the charge is to be applied while Δq moves from P to Q. The work done by this external agent in moving the charge by a distance $d\vec{l}$ is given by:

$$dW = -\Delta q \vec{E} \cdot d\vec{l} \dots\dots\dots (23)$$

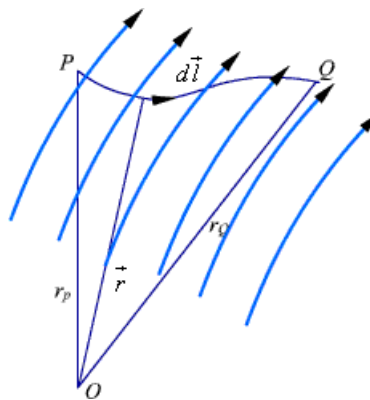

Fig 8: Movement of Test Charge in Electric Field

The negative sign accounts for the fact that work is done on the system by the external agent.

$$W = -\Delta q \int_P^Q \vec{E} \cdot d\vec{l} \dots\dots\dots (24)$$

The potential difference between two points P and Q , V_{PQ} , is defined as the work done per unit charge, i.e.

$$V_{PQ} = \frac{W}{\Delta Q} = -\int_P^Q \vec{E} \cdot d\vec{l} \dots\dots\dots (25)$$

It may be noted that in moving a charge from the initial point to the final point if the potential difference is positive, there is a gain in potential energy in the movement, external agent performs the work against the field. If the sign of the potential difference is negative, work is done by the field.

We will see that the electrostatic system is conservative in that no net energy is exchanged if the test charge is moved about a closed path, i.e. returning to its initial position. Further, the potential difference between two points in an electrostatic field is a point function; it is independent of the path taken. The potential difference is measured in Joules/Coulomb which is referred to as Volts.

Let us consider a point charge Q as shown in the Fig. 9.

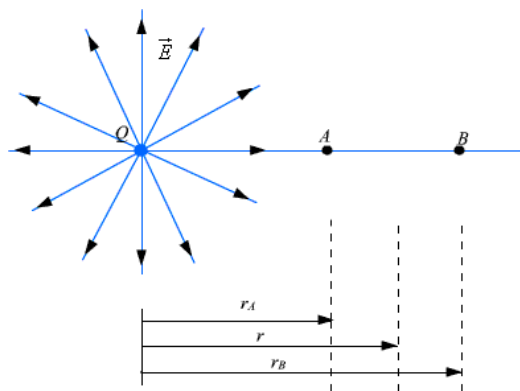

Fig 9: Electrostatic Potential calculation for a point charge

Further consider the two points A and B as shown in the Fig. 9. Considering the movement of a unit positive test charge from B to A , we can write an expression for the potential difference as:

$$V_{BA} = -\int_B^A \vec{E} \cdot d\vec{l} = -\int_{r_B}^{r_A} \frac{Q}{4\pi\epsilon_0 r^2} \hat{a}_r \cdot dr \hat{a}_r = \frac{Q}{4\pi\epsilon_0} \left[\frac{1}{r_A} - \frac{1}{r_B} \right] = V_A - V_B \dots\dots\dots(26)$$

It is customary to choose the potential to be zero at infinity. Thus potential at any point (rA = r) due to a point charge Q can be written as the amount of work done in bringing a unit positive charge from infinity to that point (i.e. rB = 0).

$$V = \frac{1}{4\pi\epsilon_0} \frac{Q}{r} \dots\dots\dots (27)$$

Or, in other words,

$$V = -\int_{\infty}^r E \cdot dl \dots\dots\dots(28)$$

Let us now consider a situation where the point charge Q is not located at the origin as shown in Fig. 10.

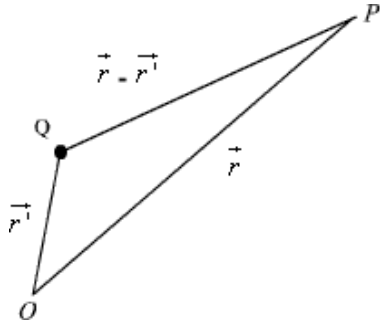

Fig 10: Electrostatic Potential due a Displaced Charge

The potential at a point P becomes

$$V(r) = \frac{Q}{4\pi\epsilon_0} \frac{1}{|\vec{r} - \vec{r}_1|} \dots\dots\dots(29)$$

So far we have considered the potential due to point charges only. As any other type of charge distribution can be considered to be consisting of point charges, the same basic ideas now can be extended to other types of charge distribution also. Let us first consider N point charges Q1, Q2 ,..... QN located at points with position vectors $\vec{r}_1, \vec{r}_2, \dots, \vec{r}_N$. The potential at a point having position vector \vec{r} can be written as:

$$V(\vec{r}) = \frac{1}{4\pi\epsilon_0} \left(\frac{Q_1}{|\vec{r} - \vec{r}_1|} + \frac{Q_2}{|\vec{r} - \vec{r}_2|} + \dots + \frac{Q_N}{|\vec{r} - \vec{r}_N|} \right) \dots\dots\dots(30a)$$

OR

$$V(\vec{r}) = \frac{1}{4\pi\epsilon_0} \sum_{i=1}^N \frac{Q_i}{|\vec{r} - \vec{r}_i|} \dots\dots\dots(30b)$$

For continuous charge distribution, we replace point charges Qn by corresponding charge elements $\rho_L dl$ or $\rho_S ds$ or $\rho_V dv$ depending on whether the charge distribution is linear, surface or a volume charge distribution and the summation is replaced by an integral. With these modifications we can write:

$$V(\vec{r}) = \frac{1}{4\pi\epsilon_0} \int_L \frac{\rho_L(\vec{r}') d\vec{l}'}{|\vec{r} - \vec{r}'|} \dots\dots\dots(31)$$

For line charge,

$$V(\vec{r}) = \frac{1}{4\pi\epsilon_0} \int_S \frac{\rho_S(\vec{r}') ds'}{|\vec{r} - \vec{r}'|} \dots\dots\dots (32)$$

For surface charge,

$$V(\vec{r}) = \frac{1}{4\pi\epsilon_0} \int_V \frac{\rho_V(\vec{r}') dv'}{|\vec{r} - \vec{r}'|} \dots\dots\dots (33)$$

For volume charge,

It may be noted here that the primed coordinates represent the source coordinates and the unprimed coordinates represent field point.

Further, in our discussion so far we have used the reference or zero potential at infinity. If any other point is chosen as reference, we can write:

$$V = \frac{Q}{4\pi\epsilon_0 r} + C \dots\dots\dots(34)$$

where C is a constant. In the same manner when potential is computed from a known electric field we can write:

$$V = -\int \vec{E} \cdot d\vec{l} + C \dots\dots\dots (35)$$

The potential difference is however independent of the choice of reference.

$$V_{AB} = V_B - V_A = -\int_A^B \vec{E} \cdot d\vec{l} = \frac{W}{Q} \dots\dots\dots(36)$$

We have mentioned that electrostatic field is a conservative field; the work done in moving a charge from one point to the other is independent of the path. Let us consider moving a charge from point P1 to P2 in one path and then from point P2 back to P1 over a different path. If the work done on the two paths were different, a net positive or negative amount of work would have been done when the body returns to its original position P1. In a conservative field there is no mechanism for dissipating energy corresponding to any positive work neither any source is present from which energy could be absorbed in the case of negative work. Hence the question of different works in two paths is untenable; the work

must have to be independent of path and depends on the initial and final positions.

Since the potential difference is independent of the paths taken, $V_{AB} = -V_{BA}$, and over a closed path,

$$V_{BA} + V_{AB} = \oint \vec{E} \cdot d\vec{l} = 0 \dots\dots\dots(37)$$

Applying Stokes's theorem, we can write:

$$\oint \vec{E} \cdot d\vec{l} = \int (\nabla \times \vec{E}) \cdot d\vec{s} = 0 \dots\dots\dots (38)$$

from which it follows that for electrostatic field,

$$\nabla \times \vec{E} = 0 \dots\dots\dots(39)$$

Any vector field that satisfies is called an irrotational field.

From our definition of potential, we can write

$$\begin{aligned} dV &= \frac{\partial V}{\partial x} dx + \frac{\partial V}{\partial y} dy + \frac{\partial V}{\partial z} dz = -\vec{E} \cdot d\vec{l} \\ \left(\frac{\partial V}{\partial x} \hat{a}_x + \frac{\partial V}{\partial y} \hat{a}_y + \frac{\partial V}{\partial z} \hat{a}_z \right) \cdot (dx \hat{a}_x + dy \hat{a}_y + dz \hat{a}_z) &= -\vec{E} \cdot d\vec{l} \\ \nabla V \cdot d\vec{l} &= -\vec{E} \cdot d\vec{l} \dots\dots\dots(40) \end{aligned}$$

from which we obtain,

$$\vec{E} = -\nabla V \dots\dots\dots (41)$$

From the foregoing discussions we observe that the electric field strength at any point is the negative of the potential gradient at any point, negative sign shows that \vec{E} is directed from higher to lower values of V . This gives us another method of computing the electric field, i. e. if we know the potential function, the electric field may be computed. We may note here that that one scalar function V contain all the information that three components of \vec{E} carry, the same is possible because of the fact that three components of \vec{E} are interrelated by the relation $\nabla \times \vec{E} = 0$.

Equipotential Surfaces

An equipotential surface refers to a surface where the potential is constant. The intersection of an equipotential surface with an plane surface results into a path called an equipotential line. No work is done in moving a charge from one point to the other along an equipotential line or surface.

In figure 12, the dashes lines show the equipotential lines for a positive point charge. By symmetry, the equipotential surfaces are spherical surfaces and the equipotential lines are circles. The solid lines show the flux lines or electric lines of force.

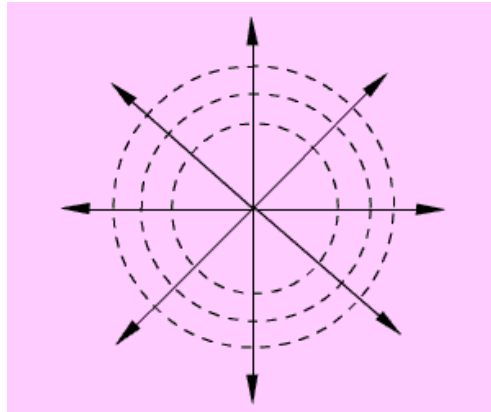

Fig 12: Equipotential Lines for a Positive Point Charge

Michael Faraday as a way of visualizing electric fields introduced flux lines. It may be seen that the electric flux lines and the equipotential lines are normal to each other. In order to plot the equipotential

lines for an electric dipole, we observe that for a given Q and d , a constant V requires that $\frac{\cos \theta}{r^2}$ is a constant. From this we can write $r = c_v \sqrt{\cos \theta}$ to be the equation for an equipotential surface and a family of surfaces can be generated for various values of c_v . When plotted in 2-D this would give equipotential lines.

To determine the equation for the electric field lines, we note that field lines represent the direction of \vec{E} in space. Therefore,

$$d\vec{l} = k\vec{E}, k \text{ is a constant} \dots\dots\dots(42)$$

$$\hat{a}_r dr + r d\theta \hat{a}_\theta + \hat{a}_\phi r \sin \theta = k(\hat{a}_r E_r + \hat{a}_\theta E_\theta + \hat{a}_\phi E_\phi) = d\vec{l} \dots\dots\dots(43)$$

For the dipole under consideration $\vec{E} = 0$, and therefore we can write,

$$\frac{dr}{E_r} = \frac{r d\theta}{E_\theta}$$

$$\frac{dr}{r} = \frac{2 \cos \theta d\theta}{\sin \theta} = \frac{2d(\sin \theta)}{\sin \theta} \dots\dots\dots(44)$$

Work done in moving a point charge in an electrostatic field:

We have stated that the electric potential at a point in an electric field is the amount of work required to bring a unit positive charge from infinity (reference of zero potential) to that point. To determine the energy that is present in an assembly of charges, let us first determine the amount of work required to assemble them. Let us consider a number of discrete charges Q_1, Q_2, \dots, Q_N are brought from infinity to their present position one by one. Since initially there is no field present, the amount of work done in bring Q_1 is zero. Q_2 is brought in the presence of the field of Q_1 , the work done $W_1 = Q_2 V_{21}$ where V_{21} is the potential at the location of Q_2 due to Q_1 . Proceeding in this manner, we can write, the total

work done
$$W = V_{21}Q_2 + (V_{31}Q_3 + V_{32}Q_3) + \dots + (V_{N1}Q_N + \dots + V_{N(N-1)}Q_N) \dots\dots\dots(45)$$

Had the charges been brought in the reverse order,

$$W = (V_{1N}Q_1 + \dots + V_{12}Q_1) + \dots + (V_{(N-2)(N-1)}Q_{N-2} + V_{(N-2)N}Q_{N-2}) + V_{(N-1)N}Q_{N-1} \dots\dots\dots(46)$$

Therefore,

$$2W = (V_{1N} + V_{1(N-1)} + \dots + V_{12})Q_1 + (V_{2N} + V_{2(N-1)} + \dots + V_{23} + V_{21})Q_2 \dots\dots\dots + (V_{N1} + \dots + V_{N2} + V_{N(N-1)})Q_N \dots\dots\dots(47)$$

Here V_{IJ} represent voltage at the I th charge location due to J th charge. Therefore,

$$2W = V_{11}Q_1 + \dots + V_{NN}Q_N = \sum_{I=1}^N V_{II}Q_I \quad \text{Or,} \quad W = \frac{1}{2} \sum_{I=1}^N V_{II}Q_I \dots\dots\dots(48)$$

If instead of discrete charges, we now have a distribution of charges over a volume v then we can write,

$$W = \frac{1}{2} \int_V \rho_v \phi dv \dots\dots\dots(49)$$

where ρ_v is the volume charge density and V represents the potential function.

Since, $\rho_v = \nabla \cdot \vec{D}$, we can write

$$W = \frac{1}{2} \int_V (\nabla \cdot \vec{D}) \phi dv \dots\dots\dots(50)$$

$\nabla \cdot (\phi \vec{D}) = \vec{D} \cdot \nabla \phi + \phi \nabla \cdot \vec{D}$ Using the vector identity,

, we can write

$$\begin{aligned}
 W &= \frac{1}{2} \int_V (\nabla \cdot (V \vec{D}) - \vec{D} \cdot \nabla V) dv \\
 &= \frac{1}{2} \oint_S (V \vec{D}) \cdot d\vec{s} - \frac{1}{2} \int_V (\vec{D} \cdot \nabla V) dv \dots\dots\dots(51)
 \end{aligned}$$

In the expression $\frac{1}{2} \oint_S (V \vec{D}) \cdot d\vec{s}$, for point charges, since V varies as $\frac{1}{r}$ and D varies as $\frac{1}{r^2}$, the term $V \vec{D}$ varies as $\frac{1}{r^3}$ while the area varies as r^2 . Hence the integral term varies at least as $\frac{1}{r}$ and the as surface becomes large (i.e. $r \rightarrow \infty$) the integral term tends to zero.

Thus the equation for W reduces to

$$W = -\frac{1}{2} \int_V (\vec{D} \cdot \nabla V) dv = \frac{1}{2} \int_V (\vec{D} \cdot \vec{E}) dv = \frac{1}{2} \int_V (\epsilon E^2) dv = \int_V w_e dv \dots\dots\dots(52)$$

$w_e = \frac{1}{2} \epsilon E^2$, is called the energy density in the electrostatic field.

Maxwell's first law:

Statement:The following Electrostatic Field equations will be developed in this section:

Integral form

Differential forms

$$\oint_{\text{Surface}} \mathbf{D} \cdot d\mathbf{a} = \int_{\text{Volume}} \rho dv.$$

$$\nabla \cdot \mathbf{D} = \rho.$$

$$\text{div } \mathbf{D} = \rho$$

Maxwell's first equation is based on Gauss' law of electrostatics published in 1832, wherein Gauss established the relationship between static electric charges and their accompanying static fields.

The above integral equation states that the electric flux through a closed surface area is equal to the total charge enclosed.

The differential form of the equation states that the divergence or outward flow of electric flux from a point is equal to the volume charge density at that point.

Divergence:

The divergence represents the volume density of the outward flux of a vector field from an infinitesimal volume around a given point.

The following properties can all be derived from the ordinary differentiation rules of calculus. Most importantly, the divergence is a linear operator, i.e.

$$\text{div}(a\mathbf{F} + b\mathbf{G}) = a \text{div } \mathbf{F} + b \text{div } \mathbf{G}$$

for all vector fields \mathbf{F} and \mathbf{G} and all real numbers a and b .

There is a product rule of the following type: if φ is a scalar-valued function and \mathbf{F} is a vector field, then

$$\text{div}(\varphi\mathbf{F}) = \text{grad } \varphi \cdot \mathbf{F} + \varphi \text{div } \mathbf{F},$$

or in more suggestive notation

$$\nabla \cdot (\varphi\mathbf{F}) = (\nabla\varphi) \cdot \mathbf{F} + \varphi(\nabla \cdot \mathbf{F}).$$

Another product rule for the cross product of two vector fields \mathbf{F} and \mathbf{G} in three dimensions involves the curl and reads as follows:

$$\text{div}(\mathbf{F} \times \mathbf{G}) = \text{curl } \mathbf{F} \cdot \mathbf{G} - \mathbf{F} \cdot \text{curl } \mathbf{G},$$

or

$$\nabla \cdot (\mathbf{F} \times \mathbf{G}) = (\nabla \times \mathbf{F}) \cdot \mathbf{G} - \mathbf{F} \cdot (\nabla \times \mathbf{G}).$$

The Laplacian of a scalar field is the divergence of the field's gradient:

$$\text{div}(\nabla\varphi) = \Delta\varphi.$$

The divergence of the curl of any vector field (in three dimensions) is equal to zero:

$$\nabla \cdot (\nabla \times \mathbf{F}) = 0$$

Poisson's and Laplace's Equations:

For electrostatic field, we have seen that

$$\begin{aligned} \nabla \cdot \vec{D} &= \rho_v \\ \vec{E} &= -\nabla V \end{aligned} \dots\dots\dots(53)$$

Form the above two equations we can write

$$\nabla \cdot (\epsilon\vec{E}) = \nabla \cdot (-\epsilon\nabla V) = \rho_v \dots\dots\dots(54)$$

Using vector identity we can write, $\epsilon \nabla \cdot \nabla V + \nabla V \cdot \nabla \epsilon = -\rho_v$ (55)

For a simple homogeneous medium, ϵ is constant and $\nabla \epsilon = 0$. Therefore,

$$\nabla \cdot \nabla V = \nabla^2 V = -\frac{\rho_v}{\epsilon} \text{(56)}$$

This equation is known as Poisson's equation. Here we have introduced a new operator ∇^2 , (del square), called the Laplacian operator. In Cartesian coordinates,

$$\nabla^2 V = \nabla \cdot \nabla V = \left(\frac{\partial}{\partial x} \hat{a}_x + \frac{\partial}{\partial y} \hat{a}_y + \frac{\partial}{\partial z} \hat{a}_z \right) \cdot \left(\frac{\partial V}{\partial x} \hat{a}_x + \frac{\partial V}{\partial y} \hat{a}_y + \frac{\partial V}{\partial z} \hat{a}_z \right) \text{(57)}$$

Therefore, in Cartesian coordinates, Poisson equation can be written as:

$$\frac{\partial^2 V}{\partial x^2} + \frac{\partial^2 V}{\partial y^2} + \frac{\partial^2 V}{\partial z^2} = -\frac{\rho_v}{\epsilon} \text{(58)}$$

In cylindrical coordinates,

$$\nabla^2 V = \frac{1}{r} \frac{\partial}{\partial r} \left(r \frac{\partial V}{\partial r} \right) + \frac{1}{r^2} \frac{\partial^2 V}{\partial \phi^2} + \frac{\partial^2 V}{\partial z^2} \text{(59)}$$

In spherical polar coordinate system,

$$\nabla^2 V = \frac{1}{r^2} \frac{\partial}{\partial r} \left(r^2 \frac{\partial V}{\partial r} \right) + \frac{1}{r^2 \sin \theta} \frac{\partial}{\partial \theta} \left(\sin \theta \frac{\partial V}{\partial \theta} \right) + \frac{1}{r^2 \sin^2 \theta} \frac{\partial^2 V}{\partial \phi^2} \text{(60)}$$

At points in simple media, where no free charge is present, Poisson's equation reduces to

$$\nabla^2 V = 0 \text{(61)}$$

Which is known as Laplace's equation.

Laplace's and Poisson's equation are very useful for solving many practical electrostatic field problems where only the electrostatic conditions (potential and charge) at some boundaries are known and solution of electric field and potential is to be found throughout the volume. We shall consider such applications in the section where we deal with boundary value problems.

Solutions to Laplace's Equation in Cartesian Coordinates:

Having investigated some general properties of solutions to Poisson's equation, it is now appropriate to study specific methods of solution to Laplace's equation subject to boundary conditions. Exemplified by this and the next section are three standard steps often used in representing EQS fields. First, Laplace's equation is set up in the coordinate system in which the boundary surfaces are coordinate surfaces. Then,

the partial differential equation is reduced to a set of ordinary differential equations by separation of variables. In this way, an infinite set of solutions is generated. Finally, the boundary conditions are satisfied by superimposing the solutions found by separation of variables.

In this section, solutions are derived that are natural if boundary conditions are stated along coordinate surfaces of a Cartesian coordinate system. It is assumed that the fields depend on only two coordinates, x and y , so that Laplace's equation is (Table I)

$$\frac{\partial^2 \Phi}{\partial x^2} + \frac{\partial^2 \Phi}{\partial y^2} = 0 \quad (1)$$

This is a partial differential equation in two independent variables. One time-honored method of mathematics is to reduce a new problem to a problem previously solved. Here the process of finding solutions to the partial differential equation is reduced to one of finding solutions to ordinary differential equations. This is accomplished by the *method of separation of variables*. It consists of assuming solutions with the special space dependence

$$\Phi(x, y) = X(x)Y(y) \quad (2)$$

In (2), X is assumed to be a function of x alone and Y is a function of y alone. If need be, a general space dependence is then recovered by superposition of these special solutions. Substitution of (2) into (1) and division by Φ then gives

$$\frac{1}{X(x)} \frac{d^2 X(x)}{dx^2} = - \frac{1}{Y(y)} \frac{d^2 Y(y)}{dy^2} \quad (3)$$

Total derivative symbols are used because the respective functions X and Y are by definition only functions of x and y .

In (3) we now have on the left-hand side a function of x alone, on the right-hand side a function of y alone. The equation can be satisfied independent of x and y only if each of these expressions is constant. We denote this "separation" constant by k^2 , and it follows that

$$\frac{d^2 X}{dx^2} = -k^2 X \quad (4)$$

and

$$\frac{d^2 Y}{dy^2} = k^2 Y \quad (5)$$

These equations have the solutions

$$\begin{array}{ll} X \sim \cos kx & \text{or} \quad \sin kx \\ Y \sim \cosh ky & \text{or} \quad \sinh ky \end{array} \quad \begin{array}{l} (6) \\ (7) \end{array}$$

If $k = 0$, the solutions degenerate into

$$\begin{array}{l} X \sim \text{constant} \\ Y \sim \text{constant} \end{array} \quad \text{or} \quad \begin{array}{l} x \\ y \end{array} \quad \begin{array}{l} (8) \\ (9) \end{array}$$

The product solutions, (2), are summarized in the first four rows of Table 5.4.1. Those in the right-hand column are simply those of the middle column with the roles of x and y interchanged. Generally, we will leave the prime off the k' in writing these solutions. Exponentials are also solutions to (7). These, sometimes more convenient, solutions are summarized in the last four rows of the table.

Electric dipole:

The name given to two point charges of equal magnitude and opposite sign, separated by a distance which is small compared to the distance to the point P, at which we want to know the electric and potential fields

Dipole moment:

A stronger mathematical definition is to use **vector algebra**, since a quantity with magnitude and direction, like the dipole moment of two point charges, can be expressed in vector form

$$\mathbf{p} = q\mathbf{d}$$

Where \mathbf{d} is the displacement vector pointing from the negative charge to the positive charge. The electric dipole moment vector \mathbf{p} also points from the negative charge to the positive charge.

EFI due to an electric dipole:

To calculate electric field created by a dipole on the axial line (on the same line joining the two charges),

- All the measurement of distances are to be taken from the centre(O).
- Let the distance between O to $+q$ and O to $-q$ be ' l '. So, total length between $+q$ and $-q$ will be ' $2l$ '.
- Take a point ' p ' on the axial line at the distance ' r ' from the centre as shown in figure.

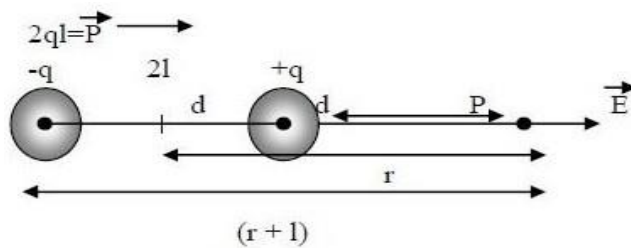

Now, we wish to calculate electric field at point 'P'.

By using the formula for electric field due to point charge,

$$\text{Electric field due to } +q = \frac{+1}{4\pi\epsilon_0} \frac{q}{(r-l)^2}$$

The distance between (P and +q) = (r-l)

$$\text{Electric field due to } -q = \frac{-1}{4\pi\epsilon_0} \frac{q}{(r+l)^2}$$

The distance between (P and -q) = (r+l)

(Electric field due to +q will be positive and electric field due to -q will be negative)

Since electric field is a vector quantity so, the net electric field will be the vector addition of the two.

So, the net electric field $E = E_1 + E_2$

$$E = \frac{1}{4\pi\epsilon_0} \frac{q}{(r-l)^2} - \frac{1}{4\pi\epsilon_0} \frac{q}{(r+l)^2}$$

$$E = \frac{q}{4\pi\epsilon_0} \left[\frac{1}{(r-l)^2} - \frac{1}{(r+l)^2} \right]$$

On solving the equation we get –

$$E = \frac{q}{4\pi\epsilon_0} \left[\frac{(r+l)^2 - (r-l)^2}{(r-l)^2(r+l)^2} \right]$$

$$E = \frac{q}{4\pi\epsilon_0} \frac{4rl}{(r^2 - l^2)^2} \dots\dots(1)$$

We know that the dipole moment or effectiveness of dipole (P) is given by –

$$P = 2ql$$

Therefore, putting this value in eq(1), we get

$$E = \frac{1}{4\pi\epsilon_0} \frac{2Pr}{(r^2 - l^2)^2} \dots\dots(2)$$

Certain assumptions are made based on this equation –

Since, the dipole is very small so 'l' is also very small as compared to the distance 'r'.

So, on neglecting 'r' with respect to 'l' we get –

$$E = \frac{1}{4\pi\epsilon_0} \frac{2Pr}{r^4} \text{ (from eq(2))}$$

$$\Rightarrow E = \frac{1}{4\pi\epsilon_0} \frac{2P}{r^2}$$

$$E = \frac{1}{4\pi\epsilon_0} \frac{2P}{r^2}$$

Note – Electric field on the axial line of dipole is not 0. Its **magnitude** is resultant as expressed above.

Torque:

An object with an electric dipole moment is subject to a torque τ when placed in an external electric field. The torque tends to align the dipole with the field. A dipole aligned parallel to an electric field has lower potential energy than a dipole making some angle with it. For a spatially uniform electric field \mathbf{E} , the torque is given by

$$\boldsymbol{\tau} = \mathbf{p} \times \mathbf{E} ,$$

where \mathbf{p} is the dipole moment, and the symbol " \times " refers to the vector cross product. The field vector and the dipole vector define a plane, and the torque is directed normal to that plane with the direction given by the right-hand rule.

A dipole oriented co- or anti-parallel to the direction in which a non-uniform electric field is increasing (gradient of the field) will experience a torque, as well as a force in the direction of its dipole moment. It can be shown that this force will always be parallel to the dipole moment regardless of co- or anti-parallel orientation of the dipole.

Torque on an Electric dipole in an electric field:

Let us assume an electric dipole is placed in a uniform magnetic field as shown in figure. Each charge of dipole experience a force qE in electric field. Since points of action of these forces are different, these equal and anti parallel forces give rise to a couple that rotate the dipole and make the dipole to align in the direction of field.

The torque τ experienced by the dipole is $(qE) \times (2d \sin\theta)$, where $2d$ is the length of dipole and θ is the angle between dipole and field direction.

$$\tau = qE \times 2d \sin\theta = (q \times 2d) \times E \sin\theta = p \times E \sin\theta = \mathbf{p} \times \mathbf{E}$$

we have used the definition of dipole moment $p = q \times 2d$ in the above equation. \mathbf{p} and \mathbf{E} are vectors representing the dipole moment and Electric field respectively.

Last step shown above is the cross product of two vectors

UNIT – II

Dielectrics & Capacitance

- Behavior of conductors in an electric field – Conductors and Insulators
- Electric field inside a dielectric material
- polarization
- Dielectric – Conductor boundary conditions
- Dielectric – Dielectric boundary conditions
- Capacitance-Capacitance of parallel plates – spherical co-axial capacitors with composite dielectrics
- Energy stored and energy density in a static electric field
- Current density
- conduction and Convection current densities
- Ohm's law in point form
- Equation of continuity

Behavior of conductors in an electric field:

Conductors:

Materials in which it is easy for charges to move around. We will discuss conductors in some depth when we discuss currents; for now, we will just summarize a few of their properties. Among the best conductors are metals — silver, gold, copper, aluminum, etc. The atoms of these metals form a crystalline structure in which electrons can easily hop around from atom to atom. Although a chunk of metal is neutral overall, we can visualize it as being made of lots of positive charges that are nailed in place, paired up with lots of negative charges (electrons) that are free to move around. In isolation, the negative charges will sit close to the positive charges, so that the metal is not only neutral overall, but also largely neutral everywhere (no local excess of positive or negative charge). Under the influence of some external field, the electrons are free to move around.

Material	Resistivity ($\Omega\text{-m}$)	Resistivity (sec)
Silver	1.6×10^{-8}	1.8×10^{-17}
Copper	1.7×10^{-8}	1.9×10^{-17}
Gold	2.4×10^{-8}	2.6×10^{-17}
Iron	1.0×10^{-7}	1.1×10^{-16}
Sea water	0.2	2.2×10^{-10}
Polyethylene	2.0×10^{11}	220
Glass	$\sim 10^{12}$	$\sim 10^3$
Fused quartz	7.5×10^{17}	8.3×10^8

Electric fields and conductors For the rest of this lecture, we will assume that conductors are materials that have an infinite supply of charges that are free to move around. (This of course just an idealization; but, it turns out to be an extremely good one. Real conductors in fact behave very similar to this limit.) From this, we can deduce a few important facts about conductors and electrostatic fields

- **There is no electric field inside a conductor:** Why? Suppose we bring a plus charge near a conductor. For a very short moment, there will be an electric field inside the conductor. However, this field will act on and move the electrons, which are free to move about. The electrons will move close to the plus charge, leaving net positive charge behind. The conductor's charges will continue to move until the "external" E_{\sim} -field is cancelled out — at that point there is no longer an E_{\sim} -field to move them, so they stay still.

- **Net charge can only reside on the surface of a conductor:** This is easily proved with Gauss's law: make a little Gaussian surface that is totally contained inside the conductor. Since there is no E_{\sim} -field inside the conductor, $\oint E_{\sim} \cdot dA_{\sim}$ is clearly zero for your surface. Since that is equal to the charge the surface contains, there can be no charge. We will discuss the charge on the conductor's surface in a moment.

- **The electric potential within a conductor is constant.** Proof: the potential difference between any two points \vec{a} and \vec{b} inside the conductor is

$$\begin{aligned}\phi_b - \phi_a &= - \int_{\vec{a}}^{\vec{b}} \vec{E} \cdot d\vec{s} \\ &= 0\end{aligned}$$

since $\vec{E} = 0$ inside the conductor. Hence, for any two points \vec{a} and \vec{b} inside the conductor, $\phi_b = \phi_a$.

- **Any external electric field lines are perpendicular to the surface:** Another way to put this is that there is no component of electric field that is tangent to the surface. We prove this by contradiction: suppose that a component of the \vec{E} -field were tangent to the surface. If that were the case, then charges would flow along the surface. They would continue to flow until there was no longer any tangential component to the \vec{E} -field. Hence, this situation cannot exist: even if it exists momentarily, it will rapidly (within 10–17 seconds or so) correct itself.
- **The conductor's surface is an equipotential:** This follows from the fact that the \vec{E} -field is perpendicular to the surface. We do a line integral of \vec{E} on the surface; the path is perpendicular to the field; so the difference in potential between any two points on the surface is zero.

Insulators:

Insulators, on the other hand, are substances that have exactly the opposite effect on the flow of electrons. These substances impede the free flow of electrons, thereby inhibiting the flow of electrical current. Insulators contain atoms that hold on to their electrons tightly which restrict the flow of electrons from one atom to another. Because of the tightly bound electrons, they are not able to roam around freely. In simple terms, substances that prevent the flow of current are insulators. The materials have such low conductivity that the flow of current is almost negligible, thus they are commonly used to protect us from dangerous effects of electricity.

Some common examples of insulators are glass, plastic, ceramics, paper, rubber, etc. The flow of current in electronic circuits is not static and voltage can be quite high at times, which makes it a little vulnerable. Sometimes the voltage is high enough to cause electric current to flow through materials that are not even considered as good conductors of electricity. This can cause electric shock because human body is also a good conductor of electricity. Therefore, electric wires are coated with rubber which acts as an insulator which in turn protects us from the conductor inside.

Conductors vs. Insulators: Comparison Chart

Conductors	Insulators
Conductors are materials that allow free flow of electrons from one atom to another.	Insulators won't allow free of electrons from one atom to another.
Conductors conduct electricity because of the free electrons present in them.	Insulators insulate electricity because of the tightly bound electrons present within atoms.
These materials can pass electricity through them.	Insulating materials cannot pass electric current through them.
Atoms are not able to hold onto their electrons tightly.	Atoms have tightly bound electrons thereby unable to transfer electrical energy well.
Materials that are good conductors generally have high conductivity.	Good insulating materials usually have low conductivity.
Mostly metals are good conductors such as copper, aluminum, silver, iron, etc.	Common insulators include rubber, glass , ceramic , plastic, asphalt, pure water, etc.

Electric field inside a dielectric material – polarization:

DIELECTRIC CONSTANT:

- In general, all insulators are also called as dielectrics.
- In perfect dielectrics, there are no free charges existing.
- Consider an atom of the dielectric as consisting of a negative charge '-Q' and positive charge '+Q', as shown in figure below:

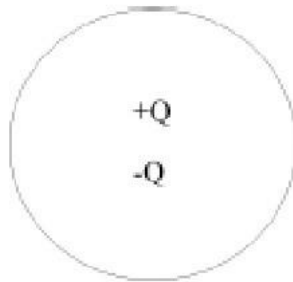

Fig: Atom of an Dielectric

- γ
e
c
- Positive charge is displaced from its original position by the force $F = +Q\bar{E}$ while the negative charge is displaced by force $F = -Q\bar{E}$.

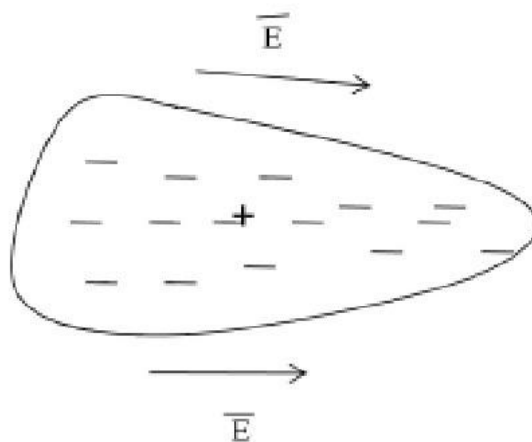

Fig: Atom when \bar{E} field is applied

- A dipole results from the displacement of the charges and the dielectric is said to be polarized.
- In the polarized state, the electron cloud is distorted by the applied electric field \bar{E} .

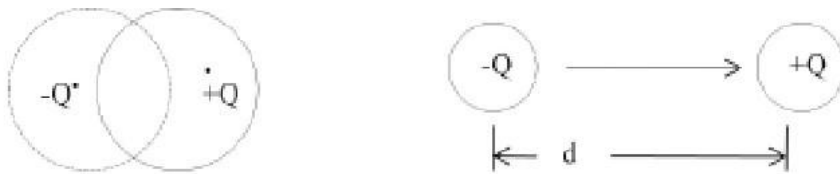

Fig: Electric Dipole

- The dipole moment is given as,

$$\vec{P} = Q\vec{d}$$

Where \vec{d} is the distance vector from $-Q$ to $+Q$ of the dipole as shown in above figure.

- Sum of all the dipole moments gives the net electric field
- The measure of intensity of the polarization is given by polarization \vec{P} (in coulombs/m²)
- Polarization \vec{P} is the dipole moment per unit volume of the dielectric; i.e

$$\vec{P} = \frac{\sum_{i=1}^N \vec{p}_i}{V}$$

Where \vec{p} is dipole moment,

\vec{P} is polarization

N is total no of electrons.

- When there is no polarization, then the electric flux density \vec{D} is given as,

$$\vec{D} = \epsilon_0 \vec{E} \text{ -----(1)}$$

$$\Rightarrow \vec{E} = \frac{\vec{D}}{\epsilon_0}$$

- In the presence of polarization, we have,

$$\vec{E} = \frac{\vec{D}}{\epsilon_0} - \frac{\vec{P}}{\epsilon_0}$$

$$\therefore \epsilon_0 \vec{E} = \vec{D} - \vec{P} \text{ -----(2)}$$

- If polarization \vec{P} and electric field intensity \vec{E} are in same direction, then \vec{P} can be expressed as,

$$\vec{P} = \epsilon_0 \chi_e \vec{E} \text{ -----(3)}$$

Where χ_e is known as the electric susceptibility of the material.

- Substituting eq. (3) in eq(2) we get

$$\begin{aligned}\bar{D} &= \epsilon_0 \bar{E} + \bar{P} \\ &= \epsilon_0 \bar{E} + \epsilon_0 X_e \bar{E} \\ \bar{D} &= \epsilon_0 (1 + X_e) \bar{E} \\ \therefore \bar{D} &= \epsilon_0 \epsilon_r \bar{E}\end{aligned}$$

$$\Rightarrow \bar{D} = \epsilon \bar{E}$$

ectric

$$\Rightarrow \epsilon_r = 1 + X_e = \frac{\epsilon}{\epsilon_0} \quad \text{----(4)}$$

Where ϵ_0 is permittivity of free space $= \frac{10^{-9}}{36\pi} F/m$

ϵ_r called the dielectric constant or relative permittivity.

- The dielectric constant (or relative permittivity). ϵ_r is the ratio of the permittivity of the dielectric to that of free space.
- The dielectric constant ϵ_r and X_e are dimension less.
- ϵ_r is always greater than or equal to unity and $\epsilon_r=1$ for free space and non-dielectric materials (such as metals).
- The minimum value of the electric field at which the dielectric breakdown occurs is called the dielectric strength of the dielectric material.
- The dielectric strength is the maximum electric field that a dielectric can tolerate or withstand without breakdown.

Boundary Conditions:

Boundary conditions is the condition that the field must satisfy at the interface separating the media

- The boundary conditions at an interface separating:
 - Dielectric and dielectric
 - Conductor and dielectric
 - Conductor and free space
- To determine the boundary conditions, we need to use Maxwell's equation:

$$\oint \mathbf{E} \cdot d\mathbf{l} = 0$$

And

$$\oint \mathbf{D} \cdot d\mathbf{S} = Q_{\text{enc}}$$

- Decomposing the electric field intensity \mathbf{E} into orthogonal components

$$\mathbf{E} = \mathbf{E}_t + \mathbf{E}_n$$

where \mathbf{E}_t and \mathbf{E}_n are, respectively, the tangential and normal components of \mathbf{E} to the interface of interest

1. Dielectric – dielectric boundary conditions:

\mathbf{E}_1 and \mathbf{E}_2 in media 1 and 2 can be decomposed as

$$\mathbf{E}_1 = \mathbf{E}_{1t} + \mathbf{E}_{1n}$$

$$\mathbf{E}_2 = \mathbf{E}_{2t} + \mathbf{E}_{2n}$$

Applying Maxwell's equation to the closed path (abcd)

$$0 = E_{1t} \Delta w - E_{1n} \frac{\Delta h}{2} - E_{2n} \frac{\Delta h}{2} - E_{2t} \Delta w + E_{2n} \frac{\Delta h}{2} + E_{1n} \frac{\Delta h}{2} \quad (1)$$

As $\Delta h \rightarrow 0$, equation (1) becomes

$$\boxed{E_{1t} = E_{2t}} \quad (2)$$

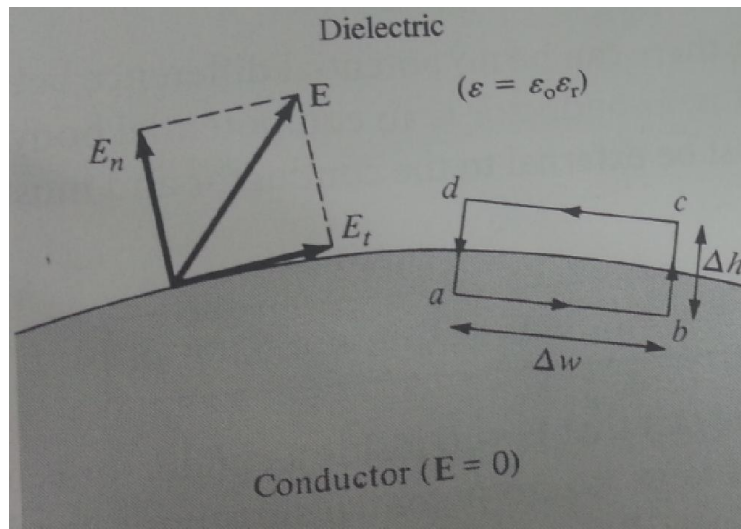

is said to be continuous across the boundary

- Since $D = \epsilon E$, eq. (2) can be written as

$$\frac{D_{1t}}{\epsilon_1} = E_{1t} = E_{2t} = \frac{D_{2t}}{\epsilon_2}$$

Or

$$\frac{D_{1t}}{\epsilon_1} = \frac{D_{2t}}{\epsilon_2}$$

is said to be discontinuous across the interface

Applying the Gauss's law, we have

$$\oint \mathbf{D} \cdot d\mathbf{S} = Q_{enc}$$

Allowing $\Delta h \rightarrow 0$ gives

$$\Delta Q = \rho_S \Delta S = D_{1n} \Delta S - D_{2n} \Delta S$$

Or

$$D_{1n} - D_{2n} = \rho_s$$

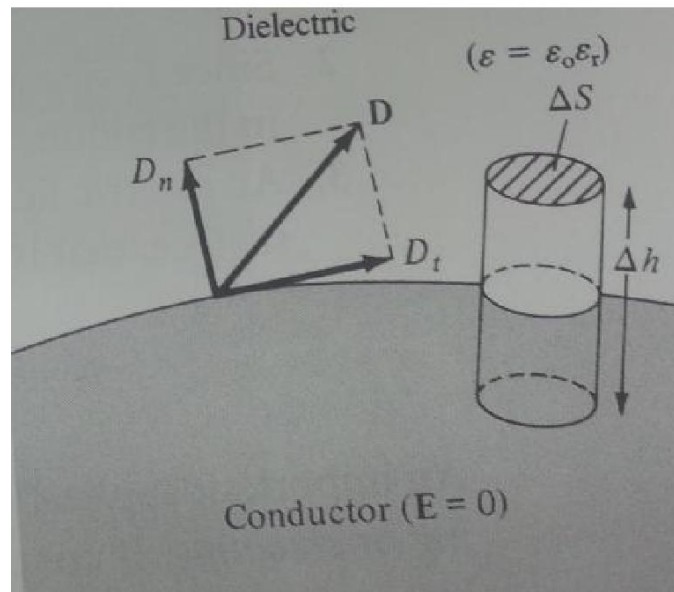

If no free charges exist at the interface , so

$$D_{1n} = D_{2n} \quad (1)$$

is continuous across the interface , since $\rho_s = 0$,eq. (1) can be written as

$$\epsilon_1 E_{1n} = \epsilon_2 E_{2n}$$

The normal component of (E) is discontinuous at the boundary

2. Conductor – dielectric boundary conditions:

Applying Maxwell's equation to the closed path (abcd)

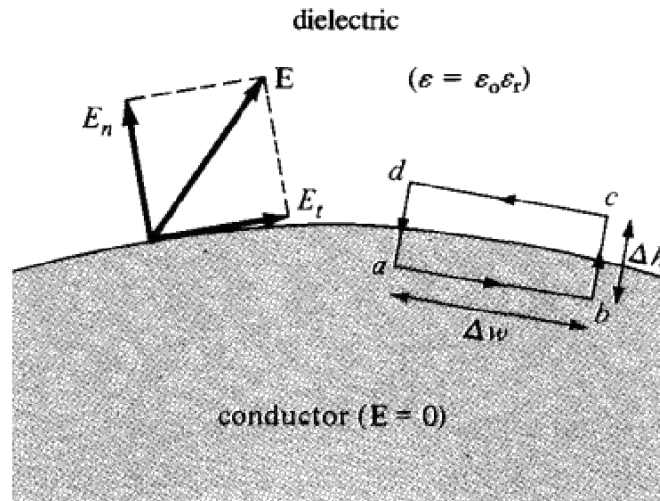

$$0 = 0 \cdot \Delta w + 0 \cdot \frac{\Delta h}{2} + E_n \cdot \frac{\Delta h}{2} - E_t \cdot \Delta w - E_n \cdot \frac{\Delta h}{2} - 0 \cdot \frac{\Delta h}{2}$$

As $\Delta h \rightarrow 0$,

$$E_t = 0$$

Similarly, by applying the Gauss's law to the pillbox and letting $\Delta h \rightarrow 0$, we have

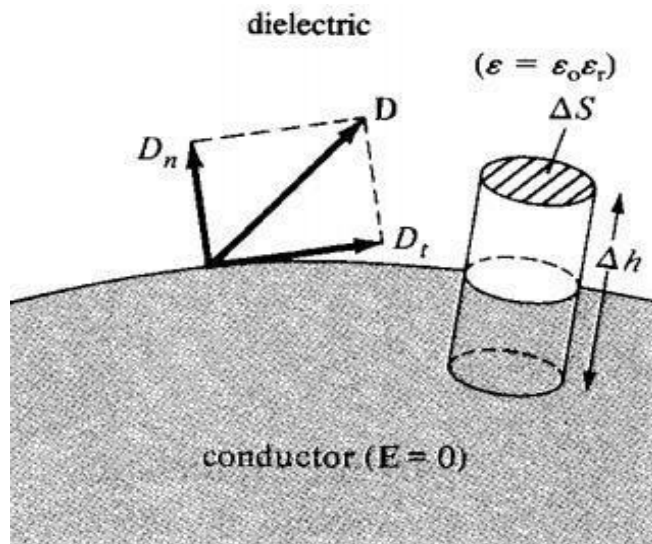

$$\Delta Q = D_n \cdot \Delta S - 0 \cdot \Delta S$$

because $D = 0$ inside the conductor, so

$$D_n = \frac{\Delta Q}{\Delta S} = \rho_S$$

Or

$$D_n = \rho_S$$

Thus under static conditions, the following conclusions can be made about a perfect conductor:

1. No electric field may exist within a conductor

$$\rho_v = 0, \quad \mathbf{E} = 0$$

2. Since $E = -\nabla V = 0$, there can be no potential difference any two points in the conductor

3. The electric field E can be external to the conductor and normal to its surface

$$D_t = \epsilon_0 \epsilon_r E_t = 0, \quad D_n = \epsilon_0 \epsilon_r E_n = \rho_S$$

3. Conductor – free space boundary conditions:

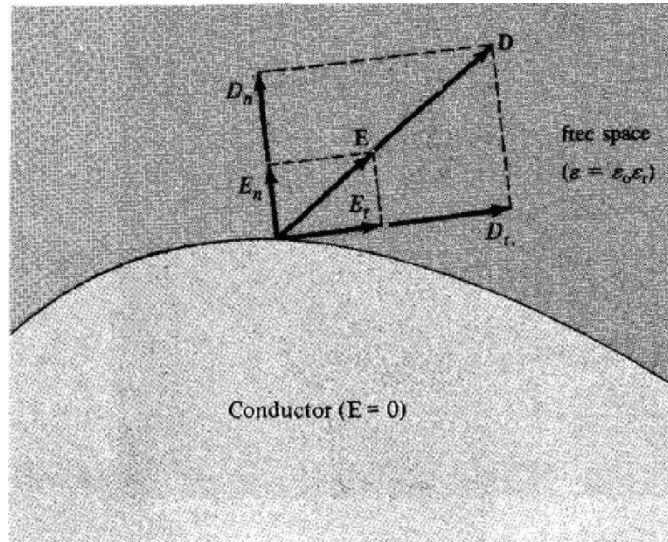

This is a special case of the conductor – dielectric condition. Free space is a special dielectric for which

$$\epsilon_1 = 1$$

Thus the boundary conditions are

$$D_t = \epsilon_0 E_t = 0, \quad D_n = \epsilon_0 E_n = \rho_s$$

Capacitance and Capacitors:

We have already stated that a conductor in an electrostatic field is an Equipotential body and any charge given to such conductor will distribute themselves in such a manner that electric field inside the conductor vanishes. If an additional amount of charge is supplied to an isolated conductor at a given potential, this additional charge will increase the surface charge density ρ_s

. Since the potential of the conductor is given by $V = \frac{1}{4\pi\epsilon_0} \int_S \frac{\rho_s ds'}{r}$, the potential of the

conductor will also increase maintaining the ratio same $\frac{Q}{V}$. Thus we can write $C = \frac{Q}{V}$ where the constant of proportionality C is called the capacitance of the isolated conductor. SI unit of capacitance is Coulomb/ Volt also called Farad denoted by F. It can be seen that if $V=1$, $C = Q$. Thus capacity of an isolated conductor can also be defined as the amount of charge in Coulomb required to raise the potential of the conductor by 1 Volt.

Of considerable interest in practice is a capacitor that consists of two (or more) conductors carrying equal and opposite charges and separated by some dielectric media or free space. The conductors may have arbitrary shapes. A two-conductor capacitor is shown in figure below.

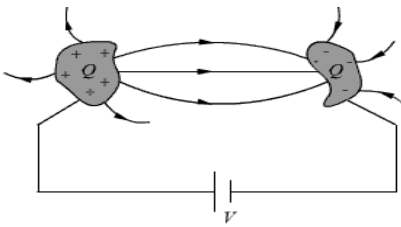

Fig : Capacitance and Capacitors

When a d-c voltage source is connected between the conductors, a charge transfer occurs which results into a positive charge on one conductor and negative charge on the other conductor. The conductors are equipotential surfaces and the field lines are perpendicular to the conductor surface. If V is the mean potential difference between the conductors, the capacitance is given by

$C = \frac{Q}{V}$. Capacitance of a capacitor depends on the geometry of the conductor and the permittivity of the medium between them and does not depend on the charge or potential difference between conductors. The capacitance can be computed by assuming Q (at the same time $-Q$ on the other conductor), first determining \vec{E} using Gauss's theorem and then determining $V = -\int \vec{E} \cdot d\vec{l}$. We illustrate this procedure by taking the example of a parallel plate capacitor.

Example: Parallel plate capacitor

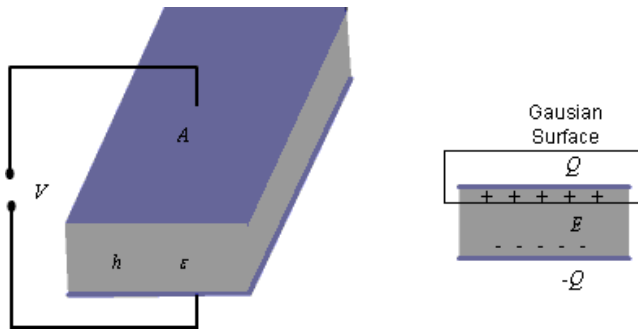

Fig : Parallel Plate Capacitor

For the parallel plate capacitor shown in the figure about, let each plate has area A and a distance h separates the plates. A dielectric of permittivity ϵ fills the region between the plates. The electric field lines are confined between the plates. We ignore the flux fringing at the edges of the plates and charges are assumed to be uniformly distributed over the conducting plates with

densities ρ_s and $-\rho_s$, $\rho_s = \frac{Q}{A}$.

By Gauss's theorem we can write, $E = \frac{\rho_s}{\epsilon} = \frac{Q}{A\epsilon}$ (1)

As we have assumed ρ_s to be uniform and fringing of field is neglected, we see that E is

constant in the region between the plates and therefore, we can write $V = Eh = \frac{hQ}{\epsilon A}$. Thus, for a parallel plate capacitor we have,

$$C = \frac{Q}{V} = \epsilon \frac{A}{h} \text{(2)}$$

Series and parallel Connection of capacitors

Capacitors are connected in various manners in electrical circuits; series and parallel connections are the two basic ways of connecting capacitors. We compute the equivalent capacitance for such connections.

Series Case: Series connection of two capacitors is shown in the figure 1. For this case we can write,

$$V = V_1 + V_2 = \frac{Q}{C_1} + \frac{Q}{C_2}$$

$$\frac{V}{Q} = \frac{1}{C_{eqs}} = \frac{1}{C_1} + \frac{1}{C_2} \dots\dots\dots(1)$$

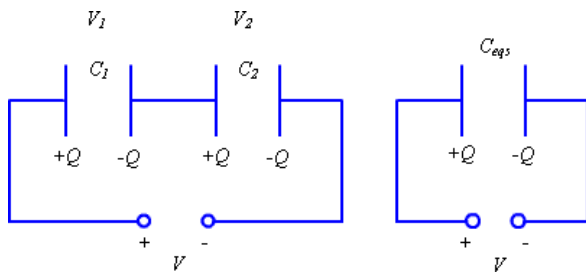

Fig 1.: Series Connection of Capacitors

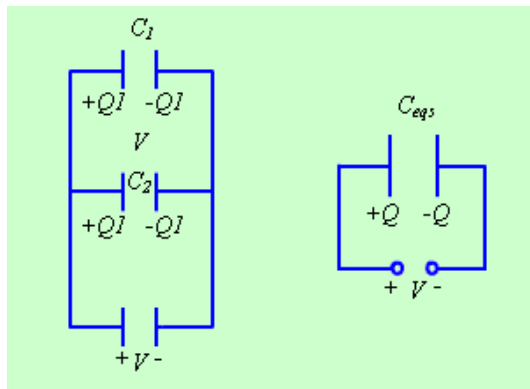

Fig 2: Parallel Connection of Capacitors

The same approach may be extended to more than two capacitors connected in series.

Parallel Case: For the parallel case, the voltages across the capacitors are the same.

The total charge $Q = Q_1 + Q_2 = C_1V + C_2V$

Therefore, $C_{eqs} = \frac{Q}{V} = C_1 + C_2 \dots\dots\dots(2)$

Energy Stored in Capacitor:

While capacitor is connected across a battery, charges come from the battery and get stored in the capacitor plates. But this process of energy storing is step by step only. At the very beginning, capacitor does not have any charge or potential. i.e. $V = 0$ volts and $q = 0$ C.

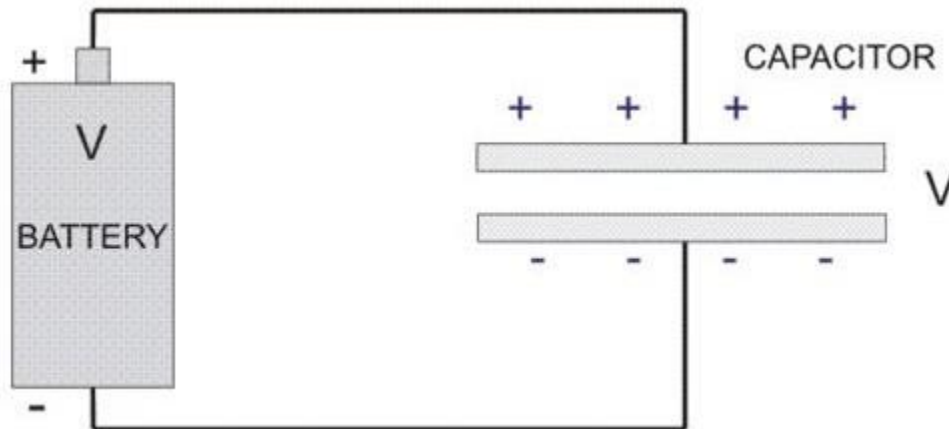

Now at the time of switching, full battery voltage will fall across the capacitor. A positive charge (q) will come to the positive plate of the capacitor, but there is no work done for this first charge (q) to come to the positive plate of the capacitor from the battery. It is because of the capacitor does not have own voltage across its plates, rather the initial voltage is due to the battery. First charge grows little amount of voltage across the capacitor plates, and then second positive charge will come to the positive plate of the capacitor, but gets repelled by the first charge. As the battery voltage is more than the capacitor voltage then this second charge will be stored in the positive plate.

At that condition a little amount of work is to be done to store second charge in the capacitor. Again for the third charge, same phenomenon will appear. Gradually charges will come to be stored in the capacitor against pre-stored charges and their little amount of work done grows up.

$$E = -\frac{dV}{dx}$$

$$\int_0^W dW = \int_0^Q V \cdot dQ$$

$$W = \int_0^Q \frac{q}{C} \cdot dq, \text{ [as } C = \frac{q}{V}] \text{ Or, } W = \frac{1}{2} \cdot \frac{Q^2}{C} \text{ Or, } W = \frac{1}{2} \cdot CV^2$$

$$W_{loss} = V \cdot Q - \frac{1}{2} \cdot Q \cdot V = \frac{1}{2} \cdot Q \cdot V$$

This half energy from total amount of energy goes to the capacitor and rest half of energy automatically gets lost from the battery and it should be kept in mind always.

Continuity Equation and Kirchhoff's Current Law

Let us consider a volume V bounded by a surface S. A net charge Q exists within this region. If a net current I flows across the surface out of this region, from the principle of conservation of charge this current can be equated to the time rate of decrease of charge within this volume. Similarly, if a net current flows into the region, the charge in the volume must increase at a rate equal to the current. Thus we can write,

$$I = -\frac{dQ}{dt} \dots\dots\dots(3)$$

$$\text{or, } \oint_S \vec{J} \cdot d\vec{s} = -\frac{d}{dt} \int_V \rho dv \dots\dots\dots(4)$$

Applying divergence theorem we can write,

$$\int_V \nabla \cdot \vec{J} dv = -\int_V \frac{\partial \rho}{\partial t} dv \dots\dots\dots(5)$$

It may be noted that, since ρ in general may be a function of space and time, partial derivatives are used. Further, the equation holds regardless of the choice of volume V, the integrands must be equal.

Therefore we can write,

$$\nabla \cdot \vec{J} = -\frac{\partial \rho}{\partial t} \dots\dots\dots(6)$$

The equation (6) is called the continuity equation, which relates the divergence of current density vector to the rate of change of charge density at a point.

For steady current flowing in a region, we have

$$\nabla \cdot \vec{J} = 0 \dots\dots\dots(7)$$

Considering a region bounded by a closed surface,

$$\oint_S \vec{J} \cdot d\vec{s} = 0 \dots\dots\dots(8)$$

which can be written as,

$$\sum_i I_i = 0 \dots\dots\dots(9)$$

when we consider the close surface essentially encloses a junction of an electrical circuit.

The above equation is the Kirchhoff's current law of circuit theory, which states that algebraic sum of all the currents flowing out of a junction in an electric circuit, is zero.

Convention and conduction current:

- The electric current is generally caused by the motion of electric charges.
- The current through a given area is the electric charge passing through the area per unit time. i.e

$$I = \frac{dQ}{dt} \text{-----(1)}$$

- Thus, in a current of one ampere, charge is being transferred at a rate of one coulomb per second.
- Let consider, the current density \vec{J} . If current ΔI flows through a surface ΔS , then the current density \vec{J} is given as,

$$J_n = \frac{\Delta I}{\Delta S}$$
$$\Rightarrow \Delta I = J_n \cdot \Delta S \text{-----(2)}$$

- The current density is assumed to be perpendicular to the surface
- If the current density is not normal to the surface, then

$$\Delta I = \vec{J} \cdot \Delta \vec{S} \text{-----(3)}$$

- Thus, the total current flowing through a surface 'S' is

$$I = \int_s \vec{J} \cdot d\vec{s} \text{-----(4)}$$

- Depending on how 'I' is produced, there are different kinds of current densities such as,
 - ✓ Convection current density
 - ✓ Conduction current density
 - ✓ Displacement current density
- We will discuss about convection and conduction densities.
- The equation (4) can be applied to any kind of current density.

Convection current Density:

- Convection current, which is different from conduction current, does not involve conductors and consequently does not satisfy Ohm's law.
- This type of current occurs when current flows through an insulating medium such as liquid, rarefied gas, or a vacuum.
- For example, a beam of electrons in a vacuum tube can be considered as convection current.
- Consider a filament as shown in figure below.

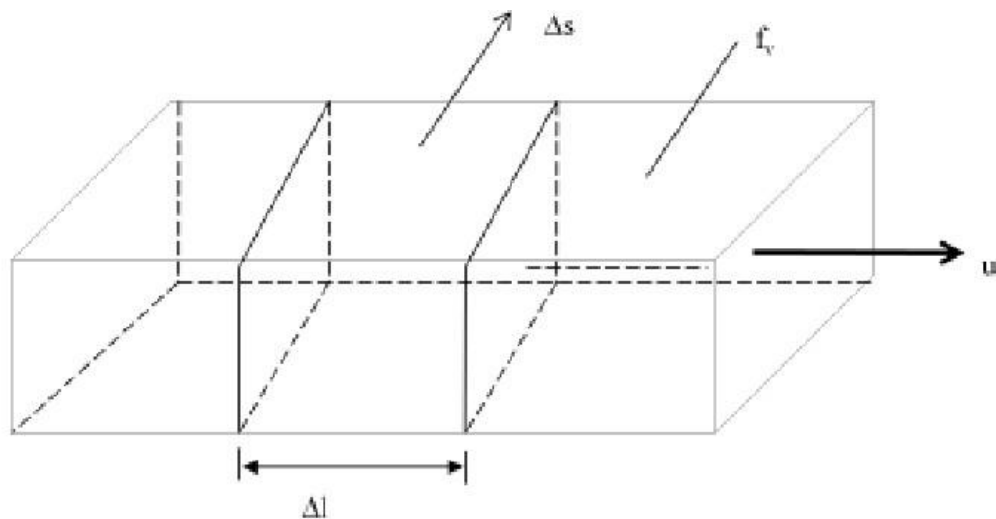

Fig: Current in a filament

- If there is a flow of charge, of density f_v , at velocity $\bar{u} = u_y \bar{a}_y$, then the current through filament is given as,

$$\text{From (1)} \Rightarrow \Delta I = \frac{\Delta Q}{\Delta t} = f_v \Delta S \frac{\Delta l}{\Delta t} \quad [\because \Delta Q = f_v \Delta S \Delta l]$$

$$\Delta I = f_v \Delta S u_y \text{-----(5)}$$

- The current density at a given point is the current through a unit normal area at that point.
- The current density ' J_y ' along the y-direction is given as,

$$J_y = \frac{\Delta I}{\Delta S}$$

$$\text{From (5), } \frac{\Delta I}{\Delta S} = f_v u_y$$

$$\therefore J_y = f_v u_y$$

Hence, in general,

$$\bar{J} = f_v \bar{u} \text{-----(6)}$$

- The current 'I' is the convection current and 'J' is the convection current density in (A/m²)

Conduction current Density:

- The conduction current to flow requires a conductor.
- The conductor has large amount of free electrons that provide conduction current due to an applied electric field.
- When an electric field \bar{E} is applied, the force on an electron with charge '-e' is given as,

$$\bar{F} = -e\bar{E} \text{-----(7)}$$

- Since the electron is not in free space, it will not under the influence of the electric field.

Ohm's law in point form:

- Rather, it suffers constant collision with the atomic lattice and drifts from one atom to another.
- If the electron with mass 'm' is moving in an electric field \bar{E} with an average drift velocity \bar{u} , according to Newton's law, the average change in momentum of the free electron must match the applied force. Thus,

$$\frac{m\bar{u}}{T} = -e\bar{E}$$

or

$$\bar{u} = -\frac{eT}{m}\bar{E}$$

Where T is the average time interval between collisions.

- If there are 'n' electrons per unit volume, the electronic charge density is given by,
 $f_v = -ne$
- Thus, the conduction current density is,

$$\bar{J} = f_v \bar{u} = \frac{ne^2T}{m} \bar{E} \left[\begin{array}{l} \because f_v = -ne \\ \bar{u} = -\frac{eT}{m} \bar{E} \end{array} \right]$$

$$\boxed{\therefore \bar{J} = \sigma \bar{E}} \text{ -----(8)}$$

Where $\sigma = \frac{ne^2T}{m}$, is the conductivity of the conductor.

- The above relationship in equation (8) known as the point form of Ohm's law.

UNIT – III

Magneto Statics

- Biot-Savart's law
 - Magnetic field intensity (MFI)
 - MFI due to a straight current carrying filament
 - MFI due to circular, square and solenoid current Carrying wire
 - Relation between magnetic flux and magnetic flux density
- Maxwell's second Equation, $\text{div}(\mathbf{B})=0$,
- Ampere's circuital law and its applications viz. MFI due to an infinite sheet of current and a long current carrying filament
- Point form of Ampere's circuital law
- Maxwell's third equation, $\text{Curl}(\mathbf{H})=\mathbf{J}_c$

Introduction:

In previous chapters we have seen that an electrostatic field is produced by static or stationary charges. The relationship of the steady magnetic field to its sources is much more complicated. The source of steady magnetic field may be a permanent magnet, a direct current or an electric field changing with time. In this chapter we shall mainly consider the magnetic field produced by a direct current. The magnetic field produced due to time varying electric field will be discussed later. Historically, the link between the electric and magnetic field was established Oersted in 1820. Ampere and others extended the investigation of magnetic effect of electricity . There are two major laws governing the magneto static fields are:

Biot-Savart Law:

Usually, the magnetic field intensity is represented by the vector \vec{H} . It is customary to represent the direction of the magnetic field intensity (or current) by a small circle with a dot or cross sign depending on whether the field (or current) is out of or into the page as shown in Fig. 1.

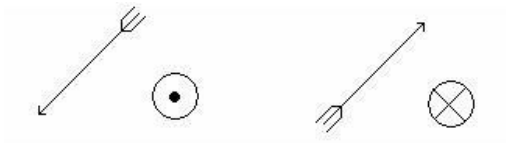

Fig. 1: Representation of magnetic field (or current)

Biot- Savart Law

This law relates the magnetic field intensity $d\vec{H}$ produced at a point due to a differential current element $d\vec{l}$ as shown in Fig. 2.

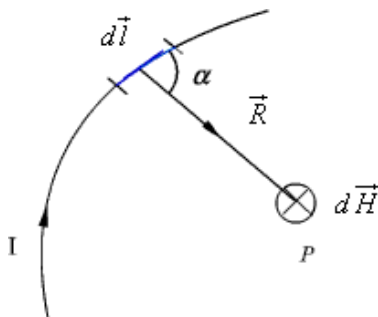

Fig. 2: Magnetic field intensity due to a current element

The magnetic field intensity $d\vec{H}$ at P can be written as,

$$d\vec{H} = \frac{Id\vec{l} \times \hat{a}_R}{4\pi R^2} = \frac{Id\vec{l} \times \vec{R}}{4\pi R^3} \dots\dots\dots(1a)$$

$$dH = \frac{Idl \sin\alpha}{4\pi R^2} \dots\dots\dots(1b)$$

Where $R = |\vec{R}|$ is the distance of the current element from the point P.

Similar to different charge distributions, we can have different current distribution such as line current, surface current and volume current. These different types of current densities are shown in Fig. 3.

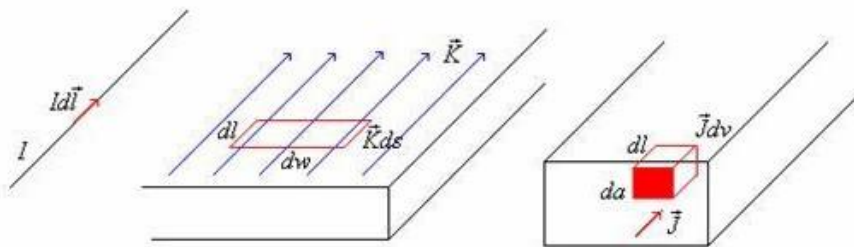

Fig. 3: Different types of current distributions

By denoting the surface current density as K (in amp/m) and volume current density as J (in amp/m²) we can write:

$$Id\vec{l} = \vec{K}ds = \vec{J}dv \dots\dots\dots(2)$$

(It may be noted that $I = Kdw = Jda$)

Employing Biot-Savart Law, we can now express the magnetic field intensity H. In terms of these current distributions.

$$\vec{H} = \int \frac{Id\vec{l} \times \vec{R}}{4\pi R^3} \dots\dots\dots \text{for line current} \dots\dots\dots(3a)$$

$$\vec{H} = \int \frac{Kd\vec{s} \times \vec{R}}{4\pi R^3} \dots\dots\dots \text{for surface current} \dots\dots\dots(3b)$$

$$\vec{H} = \int \frac{\vec{J}dv \times \vec{R}}{4\pi R^3} \dots\dots\dots \text{for volume current} \dots\dots\dots(3c)$$

MFI due to a straight current carrying filament:

Consider an infinitely long conductor AB through which current I flows. Let P be any point at a distance a from the centre of conductor. Consider dl be the small current carrying element at point c at a distance r from point p. α be the angle between r and dl. l be the distance between centre of the coil and elementary length dl. From biot-savart law, magnetic field due to current carrying element dl at point P is

$$dB = \frac{\mu_0 I dl \sin \alpha}{4\pi r^2} \text{-----(i)}$$

$$\text{from fig, } \sin \alpha = \frac{a}{r} = \cos \theta$$

$$r = \frac{a}{\cos \theta} \text{-----(ii)}$$

$$\text{again, } \tan \theta = \frac{a}{l}$$

$$dl = a \sec^2 \theta d\theta \text{-----(iii)}$$

from above three equations

$$dB = \frac{\mu_0 I a \sec^2 \theta d\theta \cos \theta}{4\pi \left(\frac{a}{\cos \theta}\right)^2}$$

$$dB = \frac{\mu_0 I a \sec^2 \theta d\theta \cos \theta}{4\pi (a)^2} \cos^2 \theta$$

$$dB = \frac{\mu_0 I \cos \theta d\theta}{4\pi a}$$

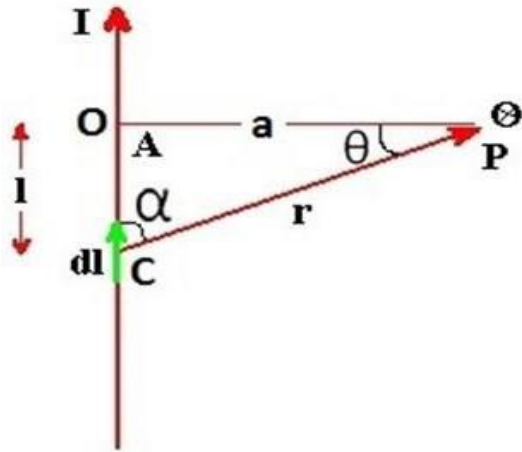

Total magnetic field due to straight current carrying conductor is

$$B = \int_{-\theta_1}^{\theta_2} \frac{\mu_0 I \cos\theta d\theta}{4\pi a}$$

$$B = \frac{\mu_0 I}{4\pi a} \int_{-\theta_1}^{\theta_2} \cos\theta d\theta$$

$$B = \frac{\mu_0 I}{4\pi a} [\sin\theta]_{-\theta_1}^{\theta_2}$$

$$B = \frac{\mu_0 I}{4\pi a} (\sin\theta_2 + \sin\theta_1)$$

This is the final expression for total magnetic field due to straight current carrying conductor.

If the conductor having infinite length then,

$$\theta_1 = \theta_2 = \frac{\pi}{2}$$

$$B = \frac{\mu_0 I}{4\pi a} \left(\sin \frac{\pi}{2} + \sin \frac{\pi}{2} \right)$$

$$B = \frac{\mu_0 I}{4\pi a} 2$$

$$B = \frac{\mu_0 I}{2\pi a} \text{ Tesla}$$

MFI due to circular current Carrying wire:

Consider a circular coil having radius a and centre O from which current I flows in anticlockwise direction. The coil is placed at YZ plane so that the centre of the coil coincide along X -axis. P be the any point at a distance x from the centre of the coil where we have to calculate the magnetic field. let dl be the small current carrying element at any point A at a distance r from the point P where

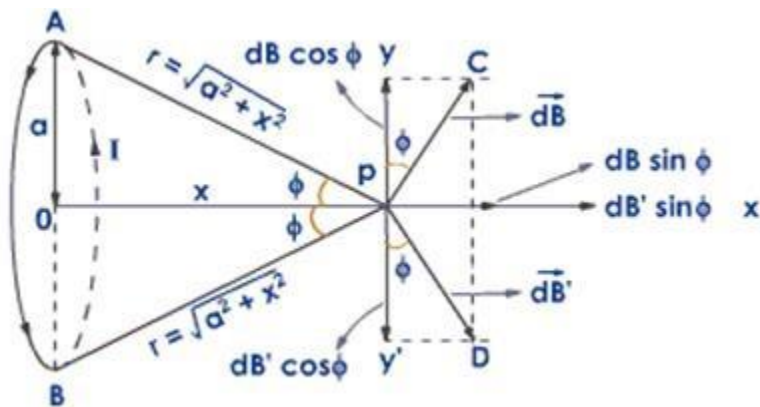

$$r = \sqrt{r^2 + a^2}$$

The angle between r and dl is 90° . Then from biot-savart law, the magnetic field due to current carrying element dl is

$$dB = \frac{\mu_0 Idl \sin\theta}{4\pi r^2} = \frac{\mu_0 Idl \sin 90}{4\pi r^2} = \frac{\mu_0 Idl}{4\pi r^2}$$

The direction of magnetic field is perpendicular to the plane containing dl and r. So the magnetic field dB has two components

dB cosθ is along the Y – axis

dB sinθ is along the X – axis

Similarly, consider another current carrying element dl' which is diametrically opposite to the point A. The magnetic field due to this current carrying element dB' also has two components

Here both dB cosθ and dB' cosθ are equal in magnitude and opposite in direction. So they cancel each other. Similarly, the components dB sinθ and dB' sinθ are equal in magnitude and in same direction so they add up

Total magnetic field due to the circular current carrying coil at the axis is

Total magnetic field due to the circular current carrying coil at the axis is

$$B = \int_0^{2\pi a} dB \sin\theta = \int_0^{2\pi a} \frac{\mu_0 Idl a}{4\pi r^2 r}$$

$$\text{since } \sin\theta = \frac{a}{r} \quad B = \int_0^{2\pi a} \frac{\mu_0 Idl}{4\pi (x^2 + a^2)} \frac{a}{(x^2 + a^2)^{\frac{1}{2}}} = \frac{\mu_0 Ia}{4\pi (x^2 + a^2)^{\frac{3}{2}}} \int_0^{2\pi a} dl$$

$$B = \frac{\mu_0 Ia}{4\pi (x^2 + a^2)^{\frac{3}{2}}} 2\pi a$$

$$B = \frac{\mu_0 Ia^2}{2 (x^2 + a^2)^{\frac{3}{2}}} \text{ Tesla}$$

This is the expression for magnetic field due to circular current carrying coil along its axis.

If the coil having N number of turns then magnetic field along its axis is

$$B = \frac{\mu_0 INa^2}{2 (x^2 + a^2)^{\frac{3}{2}}} \text{ Tesla}$$

Magnetic Flux Density:

In simple matter, the magnetic flux density \vec{B} related to the magnetic field intensity \vec{H} as $\vec{B} = \mu\vec{H}$ where μ called the permeability. In particular when we consider the free space $\vec{B} = \mu_0\vec{H}$ where $\mu_0 = 4\pi \times 10^{-7}$ H/m is the permeability of the free space. Magnetic flux density is measured in terms of Wb/m².

The magnetic flux density through a surface is given by:

$$\psi = \int_S \vec{B} \cdot d\vec{s} \quad \text{Wb} \quad \dots\dots\dots(15)$$

In the case of electrostatic field, we have seen that if the surface is a closed surface, the net flux passing through the surface is equal to the charge enclosed by the surface. In case of magnetic field isolated magnetic charge (i. e. pole) does not exist. Magnetic poles always occur in pair (as N-S). For example, if we desire to have an isolated magnetic pole by dividing the magnetic bar successively into two, we end up with pieces each having north (N) and south (S) pole as shown in Fig. 6 (a). This process could be continued until the magnets are of atomic dimensions; still we will have N-S pair occurring together. This means that the magnetic poles cannot be isolated.

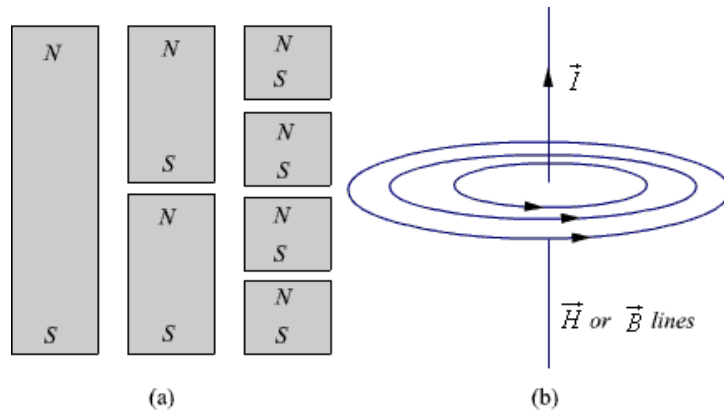

Fig. 6: (a) Subdivision of a magnet (b) Magnetic field/ flux lines of a straight current carrying conductor

Similarly if we consider the field/flux lines of a current carrying conductor as shown in Fig. 6 (b), we find that these lines are closed lines, that is, if we consider a closed surface, the number of flux lines that would leave the surface would be same as the number of flux lines that would

enter the surface.

Maxwell's second Equation, div(B)=0:

From our discussions above, it is evident that for magnetic field,

$$\oint_S \vec{B} \cdot d\vec{s} = 0 \dots\dots\dots(16)$$

which is the Gauss's law for the magnetic field.

By applying divergence theorem, we can write:

$$\oint_S \vec{B} \cdot d\vec{s} = \int_V \nabla \cdot \vec{B} dv = 0$$

Hence, $\nabla \cdot \vec{B} = 0 \dots\dots\dots(17)$

Which is the Gauss's law for the magnetic fields in point form.

Ampere's Circuital Law:

Ampere's circuital law states that the line integral of the magnetic field \vec{H} (circulation of H) around a closed path is the net current enclosed by this path. Mathematically,

$$\oint \vec{H} \cdot d\vec{l} = I_{enc} \dots\dots\dots(4)$$

The total current I enc can be written as,

$$I_{enc} = \int_S \vec{J} \cdot d\vec{s} \dots\dots\dots(5)$$

By applying Stoke's theorem, we can write

$$\begin{aligned} \oint \vec{H} \cdot d\vec{l} &= \int_S \nabla \times \vec{H} \cdot d\vec{s} \\ \therefore \int_S \nabla \times \vec{H} \cdot d\vec{s} &= \int_S \vec{J} \cdot d\vec{s} \dots\dots\dots(6) \end{aligned}$$

Which is the Ampere's law in the point form.

Applications of Ampere's law:

We illustrate the application of Ampere's Law with some examples.

Example1 : MFI due to an infinite sheet of current and a long current carrying filament:

We compute magnetic field due to an infinitely long thin current carrying conductor as shown in Fig. 4. Using Ampere's Law, we consider the close path to be a circle of radius ρ as shown in the Fig. 4.

If we consider a small current element $Id\vec{l}(= Idz\hat{a}_z)$, $d\vec{H}$ is perpendicular to the plane containing both $d\vec{l}$ and $\vec{R}(= \rho\hat{a}_\rho)$. Therefore only component of that \vec{H} will be present is H_ϕ , i.e., $\vec{H} = H_\phi\hat{a}_\phi$.

By applying Ampere's law we can write,

$$\int_0^{2\pi} H_\phi \rho d\phi = H_\phi \rho 2\pi = I \quad \dots\dots\dots(7)$$

Therefore, $\vec{H} = \frac{I}{2\pi\rho}\hat{a}_\phi$ which is same as equation (8)

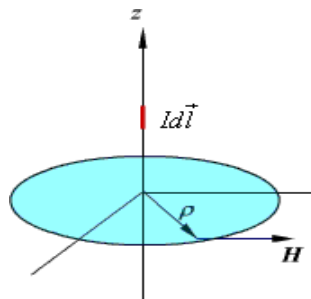

Fig. 4.:Magnetic field due to an infinite thin current carrying conductor

Example2: MFI due to infinitely long coaxial conductor:

We consider the cross section of an infinitely long coaxial conductor, the inner conductor carrying a current I and outer conductor carrying current - I as shown in figure 4.6. We compute the magnetic field as a function of ρ as follows:

In the region $0 \leq \rho \leq R_1$

$$I_{enc} = I \frac{\rho^2}{R_1^2} \quad \dots\dots\dots(9)$$

$$H_\phi = \frac{I_{enc}}{2\pi\rho} = \frac{I\rho}{2\pi R_1^2} \quad \dots\dots\dots(10)$$

In the region $R_1 \leq \rho \leq R_2$

$$I_{enc} = I$$

$$H_\phi = \frac{I}{2\pi\rho} \dots\dots\dots(11)$$

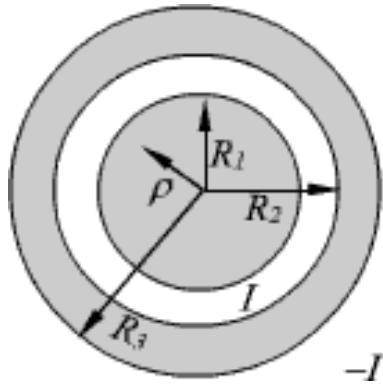

Fig. 5: Coaxial conductor carrying equal and opposite currents

In the region $R_2 \leq \rho \leq R_3$

$$I_{enc} = I - I \frac{\rho^2 - R_2^2}{R_3^2 - R_2^2} \dots\dots\dots(12)$$

$$H_\phi = \frac{I}{2\pi\rho} \frac{R_3^2 - \rho^2}{R_3^2 - R_2^2} \dots\dots\dots(13)$$

In the region $\rho > R_3$

$$I_{enc} = 0 \quad H_\phi = 0 \quad \dots\dots\dots(14)$$

UNIT – IV

Force in Magnetic fields and Magnetic Potential

- Magnetic force Moving charges in a Magnetic field – Lorentz force equation
 - Force on a current element in a magnetic field
 - Force on a straight and a long current carrying conductor in a magnetic field
 - Force between two straight long and parallel current carrying conductors
 - Magnetic dipole and dipole moment
 - a differential current loop as a magnetic dipole
 - Torque on a current loop placed in a magnetic field.
 - Scalar Magnetic potential and its limitations
 - Vector magnetic potential and its properties
 - Vector magnetic potential due to simple configurations
- Vector Poisson's equations.
- Self and Mutual inductance – Neumann's formulae
- Determination of self-inductance of a solenoid and toroid
 - Mutual inductance between a straight long wire and a square loop wire in the same plane
 - Energy stored and density in a magnetic field.
 - Introduction to permanent magnets, their characteristics and applications.

Magnetic forces:

There are three ways in which the force due to magnetic fields can be experienced. The force can be

(a) Force on a charged particle:

We have $F_e = QE$

This shows that if Q is positive, F_e and E are in same direction. It is found that the magnetic force F_m experienced by a charge Q moving with a velocity u in magnetic field B is

$$F_m = Qu \times B$$

For a moving charge Q in the presence of both electric and magnetic fields, the total force on the charge is given by

$$F = F_e + F_m$$

or

$$F = Q(E + u \times B)$$

This is known as Lorentz force equation.

(b) Force on a current element:

To determine the force on a current element Idl of a current carrying conductor due to the magnetic field B , we take the equation

$$J = P_e u$$

$$\text{We have } Idl = \frac{dQ}{dt} \cdot dl = dQ = \frac{dl}{dt} = dQu$$

Hence

$$Idl = dQu$$

This shows that an elemental charge dQ moving with velocity u (thereby producing convection current element dQu) is equivalent to a conduction current element Idl .

Thus the force on current element is give by

$$dF = Idl \times B$$

If the current I is through a closed path L or circuit, the force on the circuit is given by

$$F = \oint_L Idl \times B$$

(c) Force between two current elements:

Consider the force between two elements $I_1 dl_1$ and $I_2 dl_2$. According to biotsavarts law, both current elements produce magnetic fields. Force $d(dF_1)$ on element $I_1 dl_1$ due to field dB_2 produced by element $I_2 dl_2$ as shown in figure below:

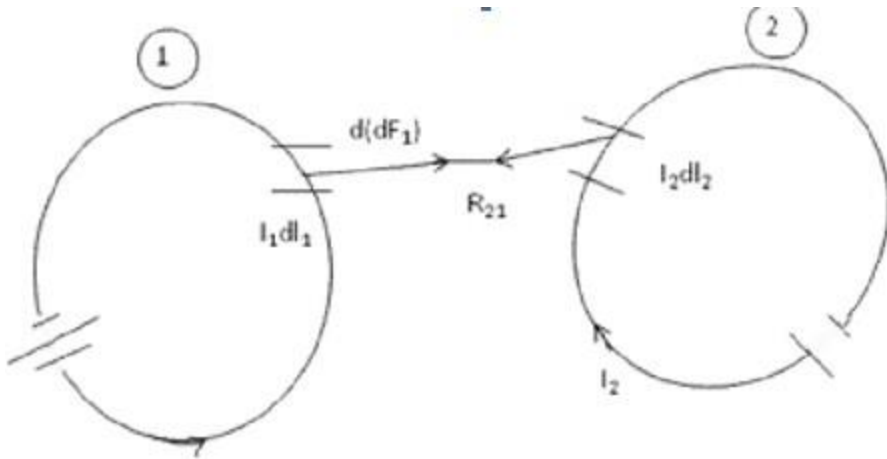

$$d(dF_1) = I_1 dl_1 \times dB_2$$

But from biot Savarts law

$$dB_2 = \frac{\mu_0 I_2 dl_2 \times a_{R21}}{4\pi R_{21}^2}$$

Hence

$$d(dF_1) = \frac{\mu_0 I_1 dl_1 \times (I_2 dl_2 \times a_{R21})}{4\pi R_{21}^2}$$

This equation is the law of force between two current elements.

$$\text{We have } F_{12} = \frac{\mu_0 I_1 I_2}{4\pi} \int_{L_1} \int_{L_2} \frac{dl_1 \times (dl_2 \times a_{R21})}{R_{21}^2}$$

Scalar Magnetic Potential and its limitations:

In studying electric field problems, we introduced the concept of electric potential that simplified the computation of electric fields for certain types of problems. In the same manner let us relate the magnetic field intensity to a scalar magnetic potential and write:

$$\vec{H} = -\nabla V_m \dots\dots\dots(18)$$

From Ampere's law , we know that

$$\nabla \times \vec{H} = \vec{J} \dots\dots\dots(19)$$

$$\text{Therefore, } \nabla \times (-\nabla V_m) = \vec{J} \dots\dots\dots(20)$$

But using vector identity, $\nabla \times (\nabla V) = 0$ we find that $\vec{H} = -\nabla V_m$ is valid only where $\vec{J} = 0$. Thus the scalar magnetic potential is defined only in the region where $\vec{J} = 0$. Moreover, V_m in general is not a single valued function of position.

This point can be illustrated as follows. Let us consider the cross section of a coaxial line as shown in fig 7.

In the region $a < \rho < b$, $\vec{J} = 0$ and $\vec{H} = \frac{I}{2\pi\rho} \hat{a}_\phi$

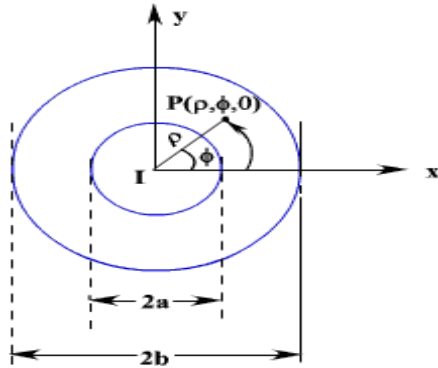

Fig. 7: Cross Section of a Coaxial Line

If V_m is the magnetic potential then,

$$\begin{aligned} -\nabla V_m &= -\frac{1}{\rho} \frac{\partial V_m}{\partial \phi} \\ &= \frac{I}{2\pi\rho} \end{aligned}$$

If we set $V_m = 0$ at $\phi = 0$ then $c = 0$ and $V_m = -\frac{I}{2\pi} \phi$

$$\therefore \text{At } \phi = \phi_0 \quad V_m = -\frac{I}{2\pi} \phi_0$$

We observe that as we make a complete lap around the current carrying conductor, we reach ϕ_0 again but V_m this time becomes

$$V_m = -\frac{I}{2\pi} (\phi_0 + 2\pi)$$

We observe that value of V_m keeps changing as we complete additional laps to pass through the same point. We introduced V_m analogous to electrostatic potential V . But for static electric fields,

$\nabla \times \vec{E} = 0$ and $\oint \vec{E} \cdot d\vec{l} = 0$ $\nabla \times \vec{H} = 0$, whereas for steady magnetic field $\nabla \times \vec{H} = 0$ wherever $\vec{J} = 0$ but $\oint \vec{H} \cdot d\vec{l} = I$ even if $\vec{J} = 0$ along the path of integration.

Vector magnetic potential due to simple configurations:

We now introduce the vector magnetic potential which can be used in regions where current density may be zero or nonzero and the same can be easily extended to time varying cases. The use of vector magnetic potential provides elegant ways of solving EM field problems.

Since $\nabla \cdot \vec{B} = 0$ and we have the vector identity that for any vector \vec{A} , $\nabla \cdot (\nabla \times \vec{A}) = 0$, we can write $\vec{B} = \nabla \times \vec{A}$.

Here, the vector field \vec{A} is called the vector magnetic potential. Its SI unit is Wb/m. Thus if can find \vec{A} of a given current distribution, \vec{B} can be found from \vec{A} through a curl operation. We have introduced the vector function \vec{B} and \vec{A} related its curl to \vec{B} . A vector function is defined fully in terms of its curl as well as divergence. The choice of $\nabla \cdot \vec{A} = 0$ is made as follows.

$$\nabla \times \nabla \times \vec{A} = \mu \nabla \times \vec{H} = \mu \vec{J} \quad \dots\dots\dots(23)$$

$$\text{By using vector identity, } \nabla \times \nabla \times \vec{A} = \nabla(\nabla \cdot \vec{A}) - \nabla^2 \vec{A} \quad \dots\dots\dots(24)$$

$$\nabla(\nabla \cdot \vec{A}) - \nabla^2 \vec{A} = \mu \vec{J} \quad \dots\dots\dots(25)$$

Great deal of simplification can be achieved if we choose $\nabla \cdot \vec{A} = 0$.

Putting $\nabla \cdot \vec{A} = 0$, we get $\nabla^2 \vec{A} = -\mu \vec{J}$ which is vector poisson equation.

In Cartesian coordinates, the above equation can be written in terms of the components as

$$\nabla^2 A_x = -\mu J_x \quad \dots\dots\dots(26a)$$

$$\nabla^2 A_y = -\mu J_y \quad \dots\dots\dots(26b)$$

$$\nabla^2 A_z = -\mu J_z \quad \dots\dots\dots(26c)$$

The form of all the above equation is same as that of

$$\nabla^2 V = -\frac{\rho}{\epsilon} \quad \dots\dots\dots(27)$$

for which the solution is

$$V = \frac{1}{4\pi\epsilon} \int_V \frac{\rho}{R} dv', \quad R = |\vec{r} - \vec{r}'| \quad \dots\dots\dots(28)$$

In case of time varying fields we shall see that $\nabla \cdot \vec{A} = \mu\epsilon \frac{\partial V}{\partial t}$, which is known as Lorentz condition, V being the electric potential. Here we are dealing with static magnetic field, so $\nabla \cdot \vec{A} = 0$.

By comparison, we can write the solution for Ax as

$$A_x = \frac{\mu}{4\pi} \int_V \frac{J_x}{R} dv' \dots\dots\dots(30)$$

Computing similar solutions for other two components of the vector potential, the vector potential can be written as

$$\vec{A} = \frac{\mu}{4\pi} \int_V \frac{\vec{J}}{R} dv' \dots\dots\dots(31)$$

This equation enables us to find the vector potential at a given point because of a volume current density \vec{J} . Similarly for line or surface current density we can write

$$\vec{A} = \frac{\mu}{4\pi} \int_V \frac{I d\vec{l}'}{R} \dots\dots\dots(32)$$

respectively. $\vec{A} = \frac{\mu}{4\pi} \int_S \frac{\vec{K}}{R} ds' \dots\dots\dots(33)$

The magnetic flux ψ through a given area S is given by

$$\psi = \int_S \vec{B} \cdot d\vec{s} \dots\dots\dots(34)$$

Substituting $\vec{B} = \nabla \times \vec{A}$

$$\psi = \int_S \nabla \times \vec{A} \cdot d\vec{s} = \oint_C \vec{A} \cdot d\vec{l} \dots\dots\dots(35)$$

Vector potential thus have the physical significance that its integral around any closed path is equal to the magnetic flux passing through that path.

Self and Mutual inductance – Neumann’s formulae:

Resistance, capacitance and inductance are the three familiar parameters from circuit theory. We have already discussed about the parameters resistance and capacitance in the earlier chapters. In this section, we discuss about the parameter inductance. Before we start our discussion, let us first introduce the concept of flux linkage. If in a coil with N closely wound turns around where a current I produces a flux ϕ and this flux links or encircles each of the N turns, the flux linkage is defined as Λ . In a linear medium $\Lambda = N\phi$, where the flux is proportional to the current, we define the self inductance L as the ratio of the total flux linkage to the current which they link.

i.e.,
$$L = \frac{\Lambda}{I} = \frac{N\phi}{I} \dots\dots\dots(36)$$

To further illustrate the concept of inductance, let us consider two closed loops C1 and C2 as shown in the figure 8, S1 and S2 are respectively the areas of C1 and C2 .

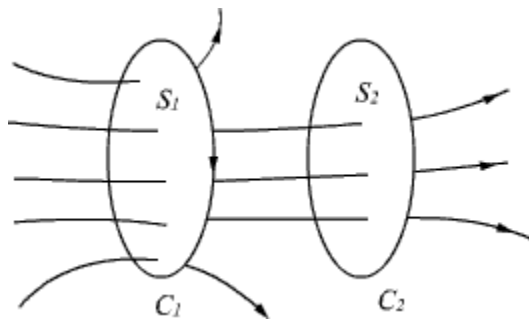

Fig:8

If a current I1 flows in C1 , the magnetic flux B1 will be created part of which will be linked to C2 as shown in Figure 8:

$$\phi_{12} = \int_{S_2} \vec{B}_1 \cdot d\vec{S}_2 \dots\dots\dots(37)$$

In a linear medium, ϕ_{12} is proportional to I 1. Therefore, we can write

$$\phi_{12} = L_{12}I_1 \dots\dots\dots(38)$$

where L12 is the mutual inductance. For a more general case, if C2 has N2 turns then

$$\Lambda_{12} = N_2\phi_{12} \dots\dots\dots(39)$$

and $\Lambda_{12} = L_{12}I_1$

or $L_{12} = \frac{\Lambda_{12}}{I_1}$ (40)

., the mutual inductance can be defined as the ratio of the total flux linkage of the second circuit to the current flowing in the first circuit.

As we have already stated, the magnetic flux produced in C1 gets linked to itself and if C1 has N1 turns then $\Lambda_{11} = N_1\phi_{11}$, where ϕ_{11} is the flux linkage per turn.

Therefore, self inductance

$$L_{11} \text{ (or } L \text{ as defined earlier)} = \frac{\Lambda_{11}}{I_1}$$
(41)

As some of the flux produced by I1 links only to C1 & not C2.

$$\Lambda_{11} = N_1\phi_{11} > N_2\phi_{12} = \Lambda_{12}$$
(42)

Further in general, in a linear medium, $L_{12} = \frac{d\Lambda_{12}}{dI_1}$ and $L_{11} = \frac{d\Lambda_{11}}{dI_1}$

Inductance:

Inductance is the ability of the material to hold energy in form of magnetic field. L, I are inductance of material and current flowing in the material.

$$E = \frac{1}{2} LI^2$$

$$\text{Inductance, } L = \frac{\text{Total flux linking current } I}{\text{current } (I)}$$

'B' is induced by I

$$\therefore \phi = \int_s \vec{B} \cdot d\vec{s}$$

Total Flux depends on no of turns

Flux linking for n turns is 'Nφ'.

$\therefore L = \frac{\lambda}{I}$	λ=Nφ(depending on condition i.e total Flux linking the current)
------------------------------------	--

Inductance of a solenoid:

In the application of ampere's law to solenoid we found that

$$B = \frac{\mu NI}{l} \text{ Tesla}$$

$$\therefore \phi = B.A = \frac{\mu NIA}{l}$$

With in a loop of N turns, the flux is linking the current N times.

$$\begin{aligned} \therefore \text{Total flux linking } I &= N\phi \\ &= \frac{\mu N^2 IA}{l} \end{aligned}$$

$$L = \frac{\lambda}{I} = \frac{\mu N^2 A}{l}$$

Some times inductors are given for unit length as well

$$\therefore \frac{l}{l} = \mu \left(\frac{N}{l} \right)^2 . A$$

Energy stored and density in a magnetic field.

Energy stored in Magnetic Field:

So far we have discussed the inductance in static forms. In earlier chapter we discussed the fact that work is required to be expended to assemble a group of charges and this work is stated as electric energy. In the same manner energy needs to be expended in sending currents through coils and it is stored as magnetic energy. Let us consider a scenario where we consider a coil in which the current is increased from 0 to a value I. As mentioned earlier, the self inductance of a coil in general can be written as

$$L = \frac{d\lambda}{di} = N \frac{d\phi}{di} \dots\dots\dots(43a)$$

$$\text{or } L di = N d\phi \dots\dots\dots(43b)$$

If we consider a time varying scenario,

$$L \frac{di}{dt} = N \frac{d\phi}{dt} \dots\dots\dots(44)$$

We will later see that $N \frac{d\phi}{dt}$ is an induced voltage.

$\therefore v = L \frac{di}{dt}$ is the voltage drop that appears across the coil and thus voltage opposes the change of current.

Therefore in order to maintain the increase of current, the electric source must do an work against this induced voltage.

$$\begin{aligned} dW &= vi dt \\ &= Li di \end{aligned} \dots\dots\dots(45)$$

$$W = \int_0^I Li di = \frac{1}{2} LI^2 \quad \text{(Joule)} \dots\dots\dots(46)$$

which is the energy stored in the magnetic circuit.

We can also express the energy stored in the coil in term of field quantities.

For linear magnetic circuit

$$W = \frac{1}{2} \frac{N\phi}{l} I^2 = \frac{1}{2} N\phi I \dots\dots\dots(47)$$

Now,
$$\phi = \int_s \vec{B} \cdot d\vec{S} = BA \dots\dots\dots(48)$$

where A is the area of cross section of the coil. If l is the length of the coil

$$\begin{aligned} NI &= Hl \\ \therefore W &= \frac{1}{2} HBAI \end{aligned} \dots\dots\dots(49)$$

Al is the volume of the coil. Therefore the magnetic energy density i.e., magnetic energy/unit volume is given by

$$W_m = \frac{W}{Al} = \frac{1}{2} BH \dots\dots\dots(50)$$

In vector form

$$W_m = \frac{1}{2} \vec{B} \cdot \vec{H} \quad \text{J/m}^3 \dots\dots\dots(51)$$

is the energy density in the magnetic field.

UNIT – V

Time Varying Fields

- Faraday's laws of electromagnetic induction – Its integral and point forms
- Maxwell's fourth equation, $\text{Curl}(\mathbf{E}) = -d\mathbf{B}/dt$
- Statically and dynamically induced EMFs – Simple problems
- Displacement current
- Modification of Maxwell's equations for time varying fields

Introduction:

In our study of static fields so far, we have observed that static electric fields are produced by electric charges, static magnetic fields are produced by charges in motion or by steady current. Further, static electric field is a conservative field and has no curl, the static magnetic field is continuous and its divergence is zero. The fundamental relationships for static electric fields among the field quantities can be summarized as:

$$\nabla \times \vec{E} = 0 \quad (1)$$

$$\nabla \cdot \vec{D} = \rho_v \quad (2)$$

For a linear and isotropic medium,

$$\vec{D} = \epsilon \vec{E} \quad (3)$$

Similarly for the magnetostatic case

$$\nabla \cdot \vec{B} = 0 \quad (4)$$

$$\nabla \times \vec{H} = \vec{J} \quad (5)$$

$$\nabla \times \vec{H} = \vec{J} \quad (6)$$

It can be seen that for static case, the electric field vectors \vec{E} and \vec{D} and magnetic field vectors \vec{B} and \vec{H} form separate pairs.

In this chapter we will consider the time varying scenario. In the time varying case we will observe that a changing magnetic field will produce a changing electric field and vice versa.

We begin our discussion with Faraday's Law of electromagnetic induction and then present the Maxwell's equations which form the foundation for the electromagnetic theory.

Faraday's Law of electromagnetic Induction:

Michael Faraday, in 1831 discovered experimentally that a current was induced in a conducting loop when the magnetic flux linking the loop changed. In terms of fields, we can say that a time varying magnetic field produces an electromotive force (emf) which causes a current in a closed circuit. The quantitative relation between the induced emf (the voltage that arises from conductors moving in a magnetic field or from changing magnetic fields) and the rate of change of flux linkage developed based on experimental observation is known as Faraday's law. Mathematically, the induced emf can be written as

$$\text{Emf} = -\frac{d\phi}{dt} \text{ Volts} \quad (7)$$

where ϕ is the flux linkage over the closed path.

A non zero $\frac{d\phi}{dt}$ may result due to any of the following:

- (a) time changing flux linkage a stationary closed path.
- (b) relative motion between a steady flux a closed path.
- (c) a combination of the above two cases.

The negative sign in equation (7) was introduced by Lenz in order to comply with the polarity of the induced emf. The negative sign implies that the induced emf will cause a current flow in the closed loop in such a direction so as to oppose the change in the linking magnetic flux which produces it. (It may be noted that as far as the induced emf is concerned, the closed path forming a loop does not necessarily have to be conductive).

If the closed path is in the form of N tightly wound turns of a coil, the change in the magnetic flux linking the coil induces an emf in each turn of the coil and total emf is the sum of the induced emfs of the individual turns, i.e.,

$$\text{Emf} = -N\frac{d\phi}{dt} \text{ Volts} \quad (8)$$

By defining the total flux linkage as

$$\lambda = N\phi \quad (9)$$

The emf can be written as

$$\text{Emf} = -\frac{d\lambda}{dt} \quad (10)$$

Continuing with equation (3), over a closed contour 'C' we can write

$$\text{Emf} = \oint_C \vec{E} \cdot d\vec{l} \quad (11)$$

where \vec{E} is the induced electric field on the conductor to sustain the current.

Further, total flux enclosed by the contour 'C' is given by

$$\phi = \int_S \vec{B} \cdot d\vec{s} \quad (12)$$

Where S is the surface for which 'C' is the contour.

From (11) and using (12) in (3) we can write

$$\oint_C \vec{E} \cdot d\vec{l} = -\frac{\partial}{\partial t} \oint_S \vec{B} \cdot d\vec{s} \quad (13)$$

By applying stokes theorem

$$\int_S \nabla \times \vec{E} \cdot d\vec{s} = -\int_S \frac{\partial \vec{B}}{\partial t} \cdot d\vec{s} \quad (14)$$

Therefore, we can write

$$\nabla \times \vec{E} = -\frac{\partial \vec{B}}{\partial t} \quad (15)$$

which is the Faraday's law in the point form

$$\frac{d\phi}{dt}$$

We have said that non zero $\frac{d\phi}{dt}$ can be produced in a several ways. One particular case is when a time varying flux linking a stationary closed path induces an emf. The emf induced in a stationary closed path by a time varying magnetic field is called a transformer emf .

Statically and dynamically induced EMFs:

Motional EMF:

Let us consider a conductor moving in a steady magnetic field as shown in the fig 2.

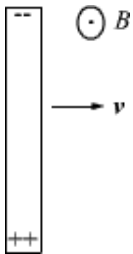

Fig 2

If a charge Q moves in a magnetic field \vec{B} it experiences a force

$$\vec{F} = Q\vec{v} \times \vec{B} \quad (16)$$

This force will cause the electrons in the conductor to drift towards one end and leave the other end positively charged, thus creating a field and charge separation continuous until electric and magnetic forces balance and an equilibrium is reached very quickly, the net force on the moving conductor is zero.

$$\frac{\vec{F}}{Q} = \vec{v} \times \vec{B}$$

can be interpreted as an induced electric field which is called the motional electric field

$$\vec{E}_m = \vec{v} \times \vec{B} \quad (17)$$

If the moving conductor is a part of the closed circuit C, the generated emf around the circuit is

$\oint_C \vec{v} \times \vec{B} \cdot d\vec{l}$. This emf is called the motional emf.

Modification of Maxwell's equations for time varying fields :

Ampere's circuit law states that the line integral of tangential component of H around a closed path is same as the net current I_{enc} enclosed by the path.

i.e.

$$\int H \cdot dl = I_{enc}$$

By applying stoke's theorem,

$$\int H \cdot dl \text{ becomes } \int J \cdot ds$$

$$\therefore \text{Therefore, } \Delta \times H = J \text{ _____ (3.14)}$$

This is true in case of static EM fields.

But in case of time-varying fields, the above Ampere's law shows some inconsistency.

The inconsistency of ampere law for time varying fields is shown in two cases:

1. For static EM fields, we have

$$\Delta \times H = J$$

Applying divergence on both sides, we get,

$$\Delta(\Delta \times H) = \Delta J$$

But divergence of curl of a vector field is always zero.

Therefore,

$$\Delta(\Delta \times H) = 0 = \Delta J$$

The continuity of current equation is given by

$$\Delta J = \frac{-dq_v}{dt}$$

Where J = Current density
 e_v = Charge density

For static fields, no current is produced, therefore, $e_v = 0 \Rightarrow \Delta J = 0$

Implies eq. 3.15 is satisfied but for time varying fields, current is produced and therefore,

$$\Delta J = \frac{-de_v}{dt} \neq 0 \quad (3.16)$$

Eq. (3.15) and eq. (3.16) are contradicting each other.

This is an inconsistency of ampere's law and the Ampere's law must be modified for time varying fields.

2. Consider the typical example of where the surface passes between the capacitor plates.

The figure is shown below.

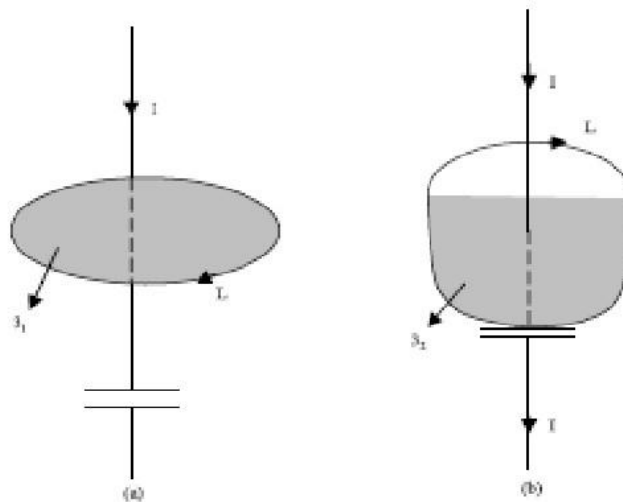

Fig 3.3 (a): Two surfaces of integration which explain the inconsistency of Ampere's law

In fig 3.3(a),

Based on Ampere's circuit law we get figure

$$\int_L H \cdot dl = \int_{S_1} J \cdot ds = I_{enc} = I \quad (3.17)$$

In fig 3.3(b), based the ampere's circuit law, we get,

$$\oint_L H \cdot dl = \int_{3_2} J \cdot ds = I_{enc} = 0 \quad (3.18)$$

Because no conduction current flows through 3_2

i.e. $J=0$

in both (a) and (b), same closed path is used, but equations 3.17 and 3.18 are different.

This is an inconsistency of Ampere's circuit law.

This inconsistency of Ampere's circuit law in both cases (1) and (2) can be resolved by including displacement current in Ampere's circuit law.

Substituting in (3.19), we get,

$$\Delta \times H = J + \frac{dD}{dt} \quad (3.21)$$

This is the Maxwell equation (based on ampere's circuit Law) for time varying fields.

In equation (3.21),

$J_d =$ Displacement current density

$J =$ Conduction current density,

The conduction current density J involves flow of charges. The displacement current density J_d does not involve flow of charges. Displacement current,

$$I_d = \int J_d \cdot ds = \int \frac{dq}{dt} \cdot ds \quad (3.22)$$

Displacement Current Density:

The equation

$\Delta \times H = J$ For static EM fields is modified to Modified to

$$\Delta \times H = J + J_d \text{ (3.19)}$$

To make the Ampere's law compatible for varying fields.

Now, applying divergence, we get

$$\Delta(\Delta \times H) = 0 = \Delta J + \Delta J_d$$

$$\Delta J_d = -\Delta J = \frac{de_v}{dt}$$

From Gauss Law, we have

$$e_v = \Delta D$$

Therefore,

$$\Delta J_d = \frac{d(\Delta D)}{dt} = \Delta \frac{dD}{dt}$$

$$\Rightarrow J_d = \frac{dD}{dt} \text{ (3.20)}$$

Concept of displacement current

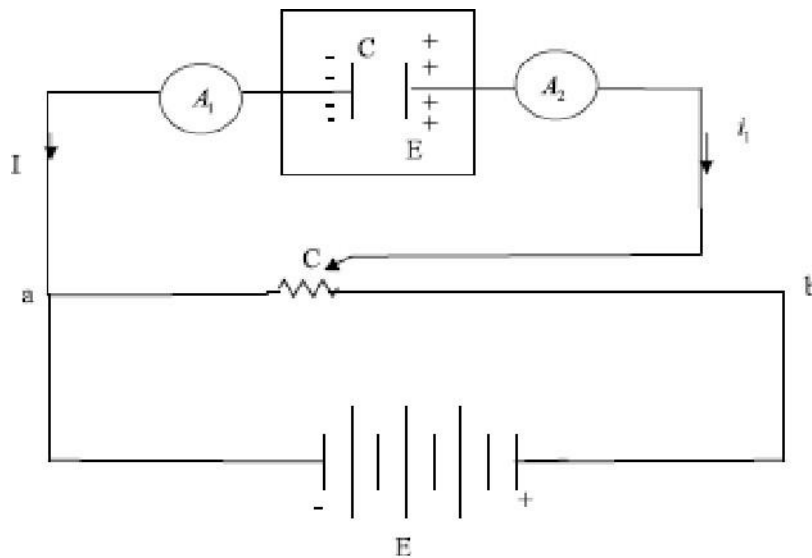

Figure 3.4: circuit for determining displacement current

Consider the circuit of fig 3.4 in which a battery is connected to a slide wire on which is a sliding contact c .

Points a and c are connected through ammeters A_1 and A_2 to a capacitance c with dielectric of permittivity E .

With the capacitance c , no current actually flows between the plates, although the electric field between the plates is increasing.

The actual phenomena that is happening is that the dielectric between the capacitor plates are exactly the same, if a current i , called by Maxwell, the displacement current were really flowing between the plates.

Hence the displacement current is seemed to flow, only when the electric field in the dielectric is changing.

The displacement current is really intended every time the current through a capacitance c is given by

$$i_d = \frac{cdv}{dt}$$

Assume c is a parallel-plate capacitor,

$$C = \frac{E_s}{d} \text{ Farads where } S = \text{ surface area}$$

$$i_d = \frac{E}{d} \frac{dv}{dt} S$$

$$= E \frac{d}{dt} \left(\frac{v}{d} \right) S$$

$$= E \frac{dE}{dt} S \text{ Where } E \text{ is electric field}$$

$$\Rightarrow i/d = \frac{dD}{dt} S$$

$$i_d = \frac{dD}{dt} S \text{ Amp}$$

Therefore,

$$\text{Displacement current } i_d = \frac{dD}{dt} S \text{ Amp}$$

Displacement current in parallel-plate capacitor is same as conduction current in the connecting wires.

Proof is given below:

Let the emf of a parallel plate capacitor along closed path is,

$$e.m.f = V_0 \sin \omega t$$

Let us consider negligible resistance in loop.

$$\Rightarrow I = \omega C V_0 \cos \omega t$$

\therefore The conduction current,

$$I = \frac{\omega E S}{d} V_0 \cos \omega t$$

Now,

Maxwell's fourth equation, Curl (E)=- dB/dt:

Equation (5.1) and (5.2) gives the relationship among the field quantities in the static field. For time varying case, the relationship among the field vectors written as

$$\nabla \times \vec{E} = -\frac{\partial \vec{B}}{\partial t} \quad (1)$$

$$\nabla \times \vec{H} = \vec{J} \dots\dots\dots(2)$$

$$\nabla \cdot \vec{D} = \rho \quad (3)$$

$$\nabla \cdot \vec{B} = 0 \quad (4)$$

In addition, from the principle of conservation of charges we get the equation of continuity

$$\nabla \cdot \vec{J} = -\frac{\partial \rho}{\partial t}$$

The equation must be consistent with equation of continuity

We observe that

$$\nabla \cdot \nabla \times \vec{H} = 0 = \nabla \cdot \vec{J} \quad (5)$$

Since $\nabla \cdot \nabla \times \vec{A}$ is zero for any vector \vec{A} .

Thus $\nabla \times \vec{H} = \vec{J}$ applies only for the static case i.e., for the scenario when $\frac{\partial \rho}{\partial t} = 0$.

A classic example for this is given below .

Suppose we are in the process of charging up a capacitor as shown in fig 3.

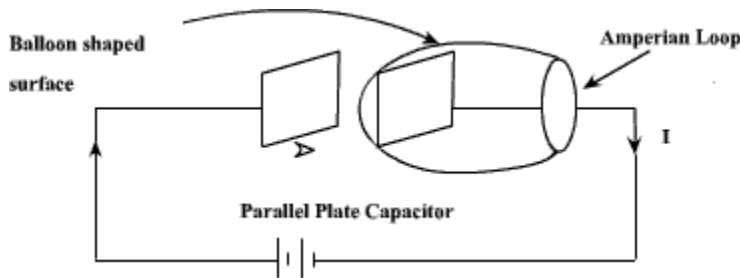

Fig 3

Let us apply the Ampere's Law for the Amperian loop shown in fig 3. $I_{enc} = I$ is the total current passing through the loop. But if we draw a balloon shaped surface as in fig 5.3, no current passes through this surface and hence $I_{enc} = 0$. But for non steady currents such as this one, the concept of current enclosed by a loop is ill-defined since it depends on what surface you use. In fact

Ampere's Law should also hold true for time varying case as well, then comes the idea of displacement current which will be introduced in the next few slides.

We can write for time varying case,

$$\begin{aligned} \nabla \cdot (\nabla \times \vec{H}) &= 0 = \nabla \cdot \vec{J} + \frac{\partial \rho}{\partial t} \\ &= \nabla \cdot \vec{J} + \frac{\partial}{\partial t} \nabla \cdot \vec{D} \end{aligned} \dots\dots\dots(1)$$

$$= \nabla \cdot \left(\vec{J} + \frac{\partial \vec{D}}{\partial t} \right) \dots\dots\dots(2)$$

$$\therefore \nabla \times \vec{H} = \vec{J} + \frac{\partial \vec{D}}{\partial t} \dots\dots\dots (3)$$

The equation (3) is valid for static as well as for time varying case. Equation (3) indicates that a

time varying electric field will give rise to a magnetic field even in the absence of The term $\frac{\partial \vec{D}}{\partial t}$ has a dimension of current densities (A/m^2) and is called the displacement current density.

Introduction of $\frac{\partial \vec{D}}{\partial t}$ in $\nabla \times \vec{H}$ equation is one of the major contributions of James Clerk Maxwell. The modified set of equations

$$\nabla \times \vec{E} = -\frac{\partial \vec{B}}{\partial t} \quad (4)$$

$$\nabla \times \vec{H} = \vec{J} + \frac{\partial \vec{D}}{\partial t} \quad (5)$$

$$\nabla \cdot \vec{D} = \rho \quad (6)$$

$$\nabla \cdot \vec{B} = 0 \quad (7)$$

is known as the Maxwell's equation and this set of equations apply in the time varying scenario,

static fields are being a particular case $\left(\frac{\partial}{\partial t} = 0 \right)$.

In the integral form

$$\oint_c \vec{E} \cdot d\vec{l} = - \int_s \frac{\partial \vec{B}}{\partial t} \cdot d\vec{S} \quad (8)$$

$$\oint_c \vec{H} \cdot d\vec{l} = \int_s \left(\vec{J} + \frac{\partial \vec{D}}{\partial t} \right) \cdot d\vec{S} = I + \int_s \frac{\partial \vec{D}}{\partial t} \cdot d\vec{S} \quad \dots\dots\dots (9)$$

$$\int_v \nabla \cdot \vec{D} \, dv = \oint_s \vec{D} \cdot d\vec{S} = \int_v \rho \, dv \quad (10)$$

$$\oint \vec{B} \cdot d\vec{S} = 0 \quad (11)$$

The modification of Ampere's law by Maxwell has led to the development of a unified electromagnetic field theory. By introducing the displacement current term, Maxwell could predict the propagation of EM waves. Existence of EM waves was later demonstrated by Hertz experimentally which led to the new era of radio communication.

